

BOOK NO. _____

CONTRACT NO. _____

CITY OF CUYAHOGA FALLS
2310 SECOND STREET
CUYAHOGA FALLS, OH 44221
Phone (330) 971-8000
Fax (330) 971-8168



TO BE COMPLETED BY THE CITY OF CUYAHOGA FALLS

DATE OF BIDDING _____, 2021 CONTRACT PRICE \$ _____

DATE AWARDED BOARD OF CONTROL _____, 2021 DATE EXECUTED _____, 2021

DEPARTMENT: ENGINEERING

ORDINANCE To Award 104-2020

**2021 SIDEWALK, CURB/RAMP &
DRIVE APPROACH REPLACEMENT
PROGRAM**

THE FOLLOWING INFORMATION MUST BE COMPLETED FOR BID CONSIDERATION

COMPANY NAME _____

CONTACT PERSON _____ PHONE No. (____) _____ FAX: _____

Email Address: _____ Alternate Phone No. _____

ADDRESS _____
STREET CITY STATE ZIP

Attach Bid Bond Here

**2021 SIDEWALK, CURB/RAMP, DRIVE APPROACH
REPLACEMENT PROGRAM
INDEX**

<u>Section</u>	<u>Title</u>	<u>Pages</u>
1	<u>INFORMATION and INSTRUCTIONS</u>	
	Legal Notice	1.1
	Pre-bid Notification	1.1.1
	Information and Instructions to Bidders	1.2
	Information and Instructions to Bidders	1.2.1
	Information and Instructions to Bidders	1.2.2
	Insurance Requirements	1.3
	Insurance Requirements	1.3.1
	Income Tax Requirements	1.4
	Drug Free Policy Letter	1.5
	Ord. 12-1990	1.5.1
	Sexual Harassment Policy	1.5.2
	Firearms Policy	1.5.3
	Weapons in the Workplace Policy	1.5.4 - 1.5.7
	Authorizing Ordinance	1.6τ
	Board of Control Minutes	1.7τ
	Bid Subject to 60-Day Acceptance	1.8
	Contractor Permit/Registration Requirements	1.9
2	<u>INSURANCE</u>	
	Certificate of Insurance (Auto and General)	2.1τ
	Workers Compensation Certificate	
	Performance Bond	
	Power of Attorney	
3	<u>CONTRACT FORMS</u>	
	Note/Certified Check or Bid Bond	3.1*
	Certificate of OSHA Compliance	3.2*
	Drug Free Certification	3.3*
	Drug Free Workplace Policy Statement	3.3.1*
	Sexual Harassment Certification	3.4*
	Firearms Certification	3.5*
	Equal Employment Opportunity	3.6
	Non-Collusion Affidavit	3.7*
	Disclosure of Personal Property Tax	3.8τ
	Prevailing Wage Requirements	3.9 to
	Prevailing Wage Requirements	3.9.3
	Public Improvement Agreement	3.10τ
	Completion Time	3.11*
	Local Bid Preference	3.12*
	Articles of Agreement	3.13τ
	Articles of Agreement Signature Page	3.13.1τ
	Certifications (Board of Control Signatures)	3.14τ
	Findings of Recovery by Auditor of State	3.15
	Findings of Recovery Certification	3.15.1*

**2021 SIDEWALK, CURB/RAMP, DRIVE APPROACH
REPLACEMENT PROGRAM**

INDEX cont.

<u>Section</u>	<u>Title</u>	<u>Pages</u>
3	<u>CONTRACT FORMS (cont'd)</u>	
	Certification of Compliance	3.16
	Certification of Compliance Certificate	3.16.1τ
	Certification of Compliance Certificate	3.16.2τ
	Construction Contract Exemption Certificate	3.17τ
4	<u>SPECIFICATIONS and PROPOSALS</u>	
	Proposal Signature Page	4.1*
	Items	4.1.1*
	Resources and Experience of Bidder	4.2*
	Qualification Information	4.2.1*
	Notice of Subcontractors	4.3*
	Attention All Bidders	4.4
	Lawn Restoration	4.4.1
	Attention General Contractors	4.5
	Specification Addendum	4.6
	Special Addendum Partial Payments	4.6.1
	General Contractor Requirements	4.7
	General Contractor Requirements cont.	4.7.1
5	<u>SPECIAL PROVISIONS</u>	
	Domestic Steel Advisory	5.1
	Addenda and Supplemental Specifications to the current construction specifications for the City of Cuyahoga Falls.	5.2 to 5.4.1
	This section also includes any special specifications and standard constructions drawings applicable to this Proposal.	
6	<u>PREVAILING WAGE</u>	
	Prevailing Wage Instructions	6.1
	Prevailing Wage Report	6.2
	Prevailing Wage Report	6.2.1
	Prevailing Wage Affidavit	6.3

* *These pages to be completely filled in, signed, notarized where required, and returned in the Proposal Book in its entirety at time of bid opening.*

τ *These pages to be inserted **after** bid awarded.*

INFORMATION AND INSTRUCTIONS

Section 1

LEGAL NOTICE

Sealed proposals will be received in the office of the Director of Public Service, Municipal Building, Cuyahoga Falls, Ohio, until 12:00 noon, **TUESDAY, MARCH 23, 2021**, with bids being opened in Conference Room "A", Second Floor, Municipal Building, 2310 2nd Street, Cuyahoga Falls, Ohio, **for annual Sidewalk, Curb/Ramp & Drive Approach Replacement Program in various locations.**

Plans and proposals may be obtained on the City website, www.cityofcf.com, free of charge. The Acknowledgement of Receipt of Plans should be returned to engineering@cityofcf.com for inclusion on the Plan Holders list. Please call 330 971-8180 with any questions.

The pre-bid meeting will be a conference call on **Monday, March 15, 2021, at 2:00 p.m.** If you wish to participate in this meeting, call: 605-313-4802, access code 702729#.

Bidders must use the printed forms provided therefore, as none other will be accepted. Each proposal must contain the full name of the party or parties making the same, and all parties interested therein, and must be accompanied by a bond or certified check in the sum of five percent (5%) of the total amount of the bid, on a solvent bank, as a guarantee that if the bid is accepted, a contract will be entered into. The Director of Public Service reserves the right to reject any or all bids and to waive any informality in any proposal. Bids will be received only from parties that have obtained a recorded bid set of drawings and specifications as evidenced by returning the provided Acknowledgement of Receipt of Plans.

The successful bidder must post a Performance, Payment, Maintenance bond in the amount of one hundred percent (100%) of the total amount of the bid.

The City of Cuyahoga Falls shall apply a Local Bid Preference to this invitation as outlined in Section 181.08 of the Codified Ordinances.

"DOMESTIC STEEL USE REQUIREMENTS AS SPECIFIED IN SECTION 153.011 OF THE REVISED CODE APPLY TO THIS PROJECT. COPIES OF SECTION 153.011 OF THE REVISED CODE CAN BE OBTAINED FROM ANY OF THE OFFICES OF THE DEPARTMENT OF ADMINISTRATIVE SERVICES."

We are an Equal Opportunity Employer.

BY ORDER OF THE
DIRECTOR OF PUBLIC SERVICE
ANTHONY L. ZUMBO, P.E., P.S.

FALLS NEWS-PRESS: March 7, 2021
 March 14, 2021

**CITY OF
CUYAHOGA FALLS, OHIO**

**PRE-BID
CONSTRUCTION MEETING**

2021 Sidewalk Curb/Ramp & Drive Approach Replacement Program

A Pre-Bid Construction Meeting will be held to review bid documents and answer questions relative to the proposed project.

This meeting will be held **by telephone conference on Monday, March 15, 2021, at 2:00 p.m. Please call 605-313-4802, access code 702729# to participate.**

Anyone obtaining the proposal book for stated project is invited to attend.

Contact person for this project is:

Craig Marko, P.E., or Bob McMasters
City Engineer's Office
971-8180

TONY DEMASI, P. E.
CITY ENGINEER

INFORMATION AND INSTRUCTIONS TO BIDDERS

1. In accordance with the advertised legal notice, sealed bids will be received by the City of Cuyahoga Falls, Ohio at the office of the Director of Public Service in the Municipal Building for certain material, equipment and/or labor services. The bids will be opened and read aloud at the time and place specified in the legal notice.
2. Bidders are advised to thoroughly examine the contract documents before submitting their bids. There may be changes in the specifications from those heretofore used. It is hereby understood that the bidder has read and fully understands each and every clause embodied therein.
3. All material, equipment and/or labor services proposed shall be in accordance with the attached specifications. Any exceptions are to be specifically noted herein.
4. Each proposal must contain the full name of the party or parties making the same and all persons interested therein.
5. All proposals or bids shall be signed and submitted on the printed blanks provided for that purpose and bound herewith. Except during the filling in of the proposal forms, no pages are to be removed from this binding. The complete set of contract documents must be submitted with the proposals. For clarity, uniformity and ease of tabulating bids all bidders are requested to TYPE their bids on the proposal forms.
6. The price bid for each unit of material equipment and/or service must be stated separately in figures in the proper column.
7. Each bidder shall submit on the proposal form the name of the manufacturer, type and catalog number of the equipment or material he proposed to furnish. He shall also submit all other data, statements and samples called for by the specifications and the data sheet forming a part of the proposal form.
8. Manufacturers or distributors failing to provide MSDS's will be considered as failing to meet contractual requirement. This statement shall appear on purchase orders or offers to bid.
9. Each bid shall be accompanied by a bond executed by the bidder and a surety company, per Ohio Revised Code, which the surety company shall be licensed to do business in the State of Ohio, in an amount not less than five (5) percent of the aggregate amount of the bid or proposal; or the bidder may submit with the bid, in lieu of such bond, a certified check on a solvent bank, payable to the order of the Director of Public Service, City of Cuyahoga Falls, Ohio, in an amount equal to the amount required in such bond. Said bond or certified check is required as a guarantee that should the said bid or proposal be accepted by the Director of Public Service, the bidder will, within ten (10) days from the time he shall have been notified of the acceptance of the same, enter into contract with the City of Cuyahoga Falls for the material, equipment and/or service bid upon.

10. Should any proposal be rejected, such check or bond will be returned to the bidder and should any proposal be accepted, such check or bond will be returned after proper execution of the contract documents. If the bidder, to whom the contract shall have been awarded shall refuse or neglect, within ten (10) days after due notice that the contract has been awarded to him, to execute the same, then the deposits shall be forfeited to the City as liquidate damages for such neglect or refusal.
11. Each proposal shall be accompanied by a non-conclusion affidavit executed on the form provided thereof.
12. When requested by the City of use in evaluation the bids submitted, the bidder must furnish satisfactory evidence of its ability, competency, facility and financial resource to furnish the material, equipment and/or labor services so bid. If the bidder represents a manufacturer, then he must submit similar data relating to the manufacturer.
13. Each bid on equipment, material and/or labor services shall contain a statement of the time, after the award of the contract, required by the bidder to deliver the equipment, material and/or labor services included in the bid.
14. Each bid shall be sealed and addressed to the Director of Public Service, City of Cuyahoga Falls, Ohio, and shall bear on its face, the name of the bidder, a statement that it is a sealed bid to be opened on the day and hour above mentioned, and statement of the item numbers on which the bid is made.
15. All bids shall be filed with the Director of Public Service, in that office in the Municipal Building, in the City of Cuyahoga Falls, Ohio, on or before the day and hour mentioned above and stated in the legal notice of advertisement. No proposal presented after that time will be accepted.
16. Permission will not be given for the modification of any proposal after the same has been filed. No bidder may withdraw his bid, for a period of thirty (30) days after the date of opening of same.
17. If any person contemplating submitting a bid for the proposed material, equipment and/or labor services is in doubt as to the true meaning of any part of the specifications or other proposed contract documents, he may submit to the Director of Public Service, a written request for an interpretation thereof. The person submitting the request will be responsible for its prompt delivery. Any interpretation of the proposed documents or changes therein will be made only by addendum duly issued and a copy of such addendum will be mailed or delivered to each person receiving a set of such documents. The Director of Public Service will not be responsible for any other explanation or interpretations of the proposed documents.
18. No bid will be accepted from, or contract awarded to, any person, firm or corporation that is in arrears to the City of Cuyahoga Falls, upon any debt or contract, or who has failed to execute, in whole or in part, in a satisfactory manner, any contract with the City; or who if a defaulter as to surety or otherwise upon any obligation to the City of Cuyahoga Falls.

19. Attention of the bidder is called to the statutory requirements of the State of Ohio relative to licensing of corporations organized under the laws of any other state.
20. Instructions must be adhered to; failure to strictly observe them shall constitute a sufficient cause of rejection of a bid.
21. the City shall not be liable for the payment of any material furnished under the contract except upon written order from the Director of Public Service supplementing this agreement, and no shipment of same shall be made under the contract except after receipt of such written order.
22. The Director of Public Service may consider bid specification items as distinct bids for each of the items such as material, equipment and/or labor services. However, all parts of any bid specification item must be bid to qualify that item for consideration.
23. After the public reading, all bids will be tabulated and upon completion of a report by the appropriate purchasing department on the bids received, the Director of Public Service will proceed, without unnecessary delay, to award contracts for the various times to the lowest and best bidders on materials, equipment and/or labor services, conforming to the specifications.
24. The Director of Public Service expressly reserves the right to reject any or all bids and to waive informalities and to judge the character and sufficiencies of equipment, apparatus, materials, and/or labor services bid upon. Bidders who are in sympathy with the purpose outlined above and prepared to act in accordance therewith, are invited to submit bids in accordance with these specifications.
25. A Performance Bond will be required (if indicated by the legal notice) of each successful bidder to assure the faithful completion of the contract that has been awarded.
26. The Performance Bond form and/or the Contract form are not to be executed by the bidder until a contract has been awarded.
27. The City expressly reserves the right to award more than one contract on any particular supply item to more than one bidder, if it is considered to be in the best interest of the City. Multiple contracts will not be considered on items obviously not suitable to such means of contracting.

End of Instructions

INSURANCE REQUIREMENTS - Amended 2/18/82

103.08 INSURANCE:

The Contractor shall not commence work under this contract until he has obtained all the insurance required under this paragraph and such insurance has been approved by the City nor shall the Contractor or any subcontractor to commence work on his subcontract until the insurance required of the subcontractor has been so obtained and approved.

1. COMPENSATION INSURANCE:

The Contractor shall procure, and shall maintain during the life of this contract, Workmen's Compensation Insurance as required by the State of Ohio for all of his employees to be engaged in work at the site of the project under this contract and, in case of any such work sublet, the Contractor shall require the subcontractor similarly to provide Workmen's Compensation Insurance for all of the latter's employees to be engaged in such work unless such employees are covered by the protection afforded by the Contractor's Workmen's Compensation Insurance. If any class of employees engaged in hazardous work on the project under this contract is not protected under the Workmen's Compensation Statute, the Contractor shall provide and shall cause each subcontractor to provide adequate employer's liability insurance for the protection of such of his employees as are not otherwise protected.

2. CONTRACTOR'S COMPREHENSIVE GENERAL LIABILITY INSURANCE AND AUTOMOBILE LIABILITY INSURANCE:

The Contractor shall procure and shall maintain, during the life of this contract, (1) Comprehensive General Liability Insurance including all Premises/Operations; Products/Completed Operations; and Broad Form Property Damage, and (2) Automobile Liability Insurance for all vehicles and equipment in the amount specified in subparagraph 2.

3. SUBCONTRACTOR'S COMPREHENSIVE GENERAL LIABILITY INSURANCE AND AUTOMOBILE LIABILITY INSURANCE:

The Contractor shall either (1) require of his subcontractors to procure and to maintain during the life OF HIS SUBCONTRACT, comprehensive, General Liability Insurance and Automobile Liability Insurance of the type and in the amount specified in Subparagraph 2 and 6 hereof or, (2) insure the activities of his policy, specified in Subparagraph 2 hereof.

4. SCOPE OF INSURANCE AND SPECIAL HAZARDS:

The insurance required under subparagraphs 2 and 3 hereof shall provide adequate protection for the Contractor and his Subcontractors, respectively, against claims which may arise from operations under this contract, whether such operations be by the insured or by anyone directly or indirectly employed by him and, also against any of the special hazards which may be encountered in the performance of this contract as enumerated in the SPECIAL PROVISIONS.

INCOME TAX REQUIREMENTS

Employers doing business within Cuyahoga Falls are required to deduct at the time of payment of salaries, wages, commissions or other compensation the tax of two (2) percent of the gross amount earned in Cuyahoga Falls.

Every employer who is required to deduct the tax at the source is liable directly to the City of Cuyahoga Falls for payment of such tax whether actually collected from their employees or not.

Also, the net profit from income earned within Cuyahoga Falls is subject to the tax. Both withholding and tax on profits are due quarterly.

CONTACT THE INCOME TAX DIVISION FOR THE NECESSARY FORMS AND ANY ADDITIONAL INFORMATION.

City of Cuyahoga Falls
Office of the Mayor

Mayor Don Walters
2310 Second Street
Cuyahoga Falls OH 44221



Phone: 330-971-8200
Fax: 330-971-5696
mayor@cityofcf.com

Dear Employer:

In today's society, we all seem to face the dangers and consequences of alcohol and drug abuse. Studies have found the workplace is not exempt from this scourge that is threatening our nation. It is found that two-thirds of those entering the workplace for the first time have used illegal drugs. Up to twenty-three percent of employees abuse alcohol/drugs on the job. The figures are staggering. Up to 100 billion dollars a year are lost in productivity.

The City of Cuyahoga Falls has passed Ordinance 12-1990, which requires employers who are awarded competitively-bid City contracts to maintain a drug-free workplace.

I have enclosed an outline of the requirements that need to be met. You will also find a sample policy statement, a certification to be completed and returned in your bid packet. It is our hope that through education and awareness, we can be an effective part of the solution.

Please know this office and I are available to assist in any way we can.

Sincerely,

A handwritten signature in black ink, appearing to read "D. Walters", written in a cursive style.

Don Walters
Mayor

Encl.

181.07 EMPLOYERS AWARDED CITY CONTRACTS TO MAINTAIN DRUG FREE WORKPLACE.

1. No contract awarded through the process of competitive bidding, other than contracts pursuant to Ohio R.C. 125.04, shall be awarded to any bidder who does not certify that the following requirements have been met:
 - a. A statement has been published and provided to employees notifying them that the manufacture, use, possession, or distribution of drugs in the work place is prohibited, as well as a specification of the disciplinary action that may be taken against employees who violate that prohibition.
 - b. Any employee convicted of violating a criminal drug statute occurring in the work place is required to notify the employer of said conviction within five days after such conviction.
 - c. Notice has been published specifying the sanctions for or requiring satisfactory participation in a drug abuse assistance or rehabilitation program by an employee convicted of violating a criminal drug statute occurring in the work place.
 - d. A program has been implemented for the distribution of information on drug abuse awareness and the availability of counseling and referral services.
2. The Board of Control may, for good cause shown, grant an extension of time for compliance of the above requirements.
3. The Drug control Coordinator be and hereby is directed to provide information and assistance necessary to facilitate compliance with the provisions of this section.

(Ord. 12-1990. Passed 1-22-90)

SEXUAL HARASSMENT POLICY

Employees of the City of Cuyahoga Falls have a right to work in an environment free of sexual harassment. The City will not tolerate any form of sexual harassment or any offensive conduct that has the effect of severely interfering with an employee's work performance or creating a pervasive intimidating, hostile, offensive work environment. Examples of sexual harassment include, but are not limited to, unwanted sexual advances; implicit or explicit demands for sexual favors in exchange for favorable treatment or continued employment; repeated sexual jokes, flirtations, advances or propositions; verbal abuse of a sexual nature; graphic, verbal commentary about an individual's body, sexual prowess or sexual deficiencies; leering; whistling; touching; pinching; assault; coerced sexual acts; suggestive insulting, obscene comments or gestures; and display in the work place of sexually suggestive objects or pictures.

It is the policy of the City of Cuyahoga Falls that any form of sexual harassment is unacceptable, either within the workplace or at City-sponsored events, whether on or off property owned by the City, and is subject to appropriate disciplinary action.

The City encourages individuals who believe they are being harassed to clearly and promptly notify the offender that his or her behavior is unwelcome. This procedure is not a required first step for reporting sexual harassment. If for any reason an individual does not wish to approach the offender directly or if such discussion does not successfully end the harassment, then the individual should notify their supervisor.

Additionally, any employee who observes harassment of any type is to report it to his or her supervisor.

All employees are expected to cooperate with an investigation of any type of harassment. Failure to do so may lead to discipline. False information provided in the course of any investigation may also lead to discipline.

The City will not retaliate against an individual who makes a report of sexual harassment, nor permit any employee to do so. Retaliation is a very serious violation of this policy and should be reported immediately. Any individual found to have retaliated against an individual for reporting sexual harassment, or against anyone participating in the investigation of a complaint, will be subject to appropriate disciplinary action.

FIREARMS POLICY

As a result of the General Assembly passing Am. Sub. House Bill 12 regarding “concealed carry” of firearms, the City of Cuyahoga Falls, Ohio, has adopted a policy. Each Bidder must review the policy and file the certification that is included in this bid packet. The policy can be accessed at the City’s website, www.cityofcf.com, or a copy can be obtained from the office of the Director of Public Service located on the 2nd floor of City Hall, 2310 Second Street, Cuyahoga Falls, Ohio. Upon request, the policy can be faxed or mailed.

A. PURPOSE

The purpose of this policy is to ensure a safe work environment, free of intimidation and threat of physical harm. This policy prohibits all employees, except law enforcement officers and security personnel, from carrying deadly weapons, including firearms, while acting in the course and scope of City employment.

No person shall knowingly possess, have under the person's control, convey or attempt to convey a deadly weapon onto City property except for those persons and circumstances specified in Section C., 2., below. This policy applies to employees, visitors, independent contractors, vendors and any other person on City property, including individuals with valid permits to carry deadly weapons and/or firearms.

B. DEFINITIONS

A "deadly weapon" is defined as any instrument, device or thing capable of inflicting death, and designed or specially adapted for use as a weapon. Examples of prohibited deadly weapons include, but are not limited to:

"Firearm" means any firearm capable of expelling or propelling one or more projectiles by the action of an explosive or combustible propellant. Firearm includes an unloaded firearm and a firearm that is inoperable but that can readily be rendered operable. Firearm includes, but is not limited to, handguns, pistols, rifles, shotguns, automatic and semi-automatic weapons and zip guns.

"Explosives" meaning any chemical compound, mixture, or device, the primary or common purpose of is to function by explosion. Explosive includes but is not limited to dynamite, black powder, pellet powders, blasting caps, fuse igniters and instantaneous fuses.

"Explosive devices" which are defined as any device designed or specially adapted to cause physical harm to persons or property by means of an explosion, and consisting of any explosive substance or agency and means to detonate it. Explosive devices include bombs, demolition devices, blasting caps or detonators containing an explosive charge and any pressurized vessel that has been knowingly tampered with or arranged so as to explode.

"Incendiary devices" which means any firebomb, and any device designed or specially adapted to cause physical harm to persons or property by means of fire and consisting of any incendiary substance or agency and means to ignite it.

Knives with a blade longer than 3.5".

"Ballistic knife" which means a knife with a detachable blade that is propelled by a spring-operated mechanism or other illegal knives.

“City property” means the vehicles, equipment, machinery, facilities and land owned, leased or under the primary control of the City of Cuyahoga Falls, including all Park and Recreation facilities and areas under construction.

“Visitor” means any person who is on City property, including independent contractors, vendors and visitors, and off-duty employees of the City of Cuyahoga Falls.

C. GENERAL PROVISIONS

No person is permitted to carry or possess a deadly weapon on City property except as provided in this policy.

1. Prohibition

Employees .Employees are prohibited from possessing or carrying a deadly weapon, including but not limited to a firearm, while acting in the course and scope of their employment, either on or off City property, regardless of whether the employee has a permit to carry a deadly weapon, except as otherwise provided in the policy.

Visitors .Visitors, vendors and independent contractors are prohibited from possessing or carrying a deadly weapon while on City property, or engaged in the course of City business or City activities, except as otherwise provided in this policy.

2. Exceptions

Law Enforcement .Law Enforcement officers, as defined in RC 2901 .01, acting within the scope of their duties, are exempt from this policy.

Security Officers .City of Cuyahoga Falls security officers and the head of security personnel, who are authorized to carry deadly weapons as a requirement of their duties, and who are acting within the scope of their duties at the time of that possession or control, are exempt from this policy.

Persons exempt pursuant to RC 2923.123

Parking Areas .This policy does not prohibit the lawful possession or carry of a concealed weapon in private vehicles in a City parking area or parking facility, provided the owner has obtained the appropriate permit(s) required under the law and stores the weapon in their own locked vehicle, either in a locked glove compartment (or other locked compartment), in the trunk, or locked inside a gun case.

Other Authorized Uses .Lawful possession or carry related to use at a City shooting range or other law-enforcement programs; Lawful discharge or possession of a deadly weapon for show or memorial purposes where no projectile is discharged; Lawful transport of an unloaded deadly weapon directly between a parking area or parking facility and the location authorized for its use, or transport of an unloaded deadly weapon directly between a parking area or parking facility and a storage facility provided by the City.

Other Authorized Persons . Individuals who have obtained written permission from the Mayor to carry or use deadly weapons or deadly weapons on City property to perform specific tasks for the City are exempt from this policy during the performance of those tasks.

D. DEADLY WEAPONS STORAGE

Deadly weapons are not permitted in any City vehicle. For purposes of this policy, City vehicles include any vehicle owned, leased or otherwise under the control of the City. City vehicles shall not be used to store or carry a deadly weapon, except as authorized for purposes under Section C. 2 above.

Nothing in this policy requires the City to provide storage facilities for employee's deadly weapon.

The City reserves the right to search all people and property in accordance with local, state and federal law.

E. VIOLATIONS BY EMPLOYEES

Violation of this policy by an employee while on duty or in the course of City business is grounds for immediate removal from City property and termination of employment. An employee who uses a deadly weapon while on duty or in the course of City business will not be defended or indemnified by the City of Cuyahoga Falls. Furthermore, the City may refer suspected violations to appropriate law enforcement authorities, as permitted by law.

Display of a deadly weapon while on or off duty on City property is considered a threat, and will subject the employee to disciplinary action up to and including termination of employment. An employee who displays an empty firearm holster while on duty, creates a physically intimidating and hostile work environment and will be subject to disciplinary action up to and including termination of employment.

F. REPORTING RESPONSIBILITY

If the employee believes that another person (visitor, independent contractor, vendor or another employee) is in possession of or carrying a deadly weapon in violation of this policy, the employee must report the suspected act immediately to the City Police Department and then his/her supervisor, unless reporting at that time would subject the employee or others to physical harm. The threat of physical harm may delay, but does not excuse this reporting requirement.

The City will not tolerate retaliation toward or harassment of any employee who, acting in good faith, reports violations of this policy.

Failure to Report . Failure to report knowledge the presence of any deadly weapon on City property in violation of this policy shall subject the employee to discipline up to and including termination of employment.

False Report .If an employee knowingly makes a false report of a suspected violation of this policy, the employee will be subject to disciplinary action, up to and including termination of employment.

G. SAFETY & ENFORCEMENT

Employees should be aware that the enforcement of this policy might deal with confronting individuals carrying potentially loaded deadly weapons. Under no circumstances should an employee take unnecessary risks or compromise his or her safety in order to enforce this policy. The Cuyahoga Falls Police Department should be contacted immediately if there is a possibility of imminent threat to the personal safety of an employee or others.

H. EMPLOYEE RESPONSIBILITY

Employees are responsible for making sure, in advance, that any potentially covered item in their possession is not prohibited by this policy. Questions regarding items covered in this policy should be directed to the City Police Department.

I. LIMITATIONS

In the event any other City policy or procedure is found to be in conflict with this policy, the terms of this policy shall govern. To the extent any federal, state or local law, rule or regulation limits or prohibits the application of any provision of this policy, then to the minimum extent necessary, this policy is deemed to be amended to be in compliance, pursuant to such law, rule or regulation.

CITY OF CUYAHOGA FALLS:

BIDS SUBJECT TO 60 DAY ACCEPTANCE

BECAUSE OF OUR DESIRE TO FAIRLY AND EQUABLY EVALUATE ALL COMPETITIVE BIDS, WE ARE SPECIFYING THAT ALL BIDS BE SUBJECT TO ACCEPTANCE BY THE CITY WITHIN 60 DAYS FROM THE DATE OF THE BID OPENING.

EXCEPTION BY THE BIDDER TO THIS REQUIREMENT MAY RESULT IN HAVING THE SUBJECT BID REJECTED BY THE CITY AS NOT HAVING MET THE CITY'S SPECIFICATIONS.

CONTRACTOR PERMIT/REGISTRATION REQUIREMENTS

The Contractor shall review and comply with the provisions of any and all permits issued for this work, including compliance with contractor registration, insurance and/or bonding provisions. Although City of Cuyahoga Falls permit fees for this work, if applicable, will be waived, costs for City of Cuyahoga Falls contractor registration, if applicable, will not.

INSURANCE

Section 2

CONTRACT FORMS

Section 3

(DIRECTOR OF PUBLIC SERVICE)

NOTE

The bidder hereby agrees that the Director of Public Service has the right to reject any or all bids and to waive informality in any bid and that the bidder shall not dispute the correctness of the quantities used in computing the lowest and best bid.

The bidder further agrees that the Director of Public Service may at his discretion award the contract on the basis of individual items taken separately in multiples or collectively for any or all items in this proposal and that he will not dispute the Director's judgment in his award upon this basis.

Signature of Officer, Partner or Owner

(Business address of bidder)

CERTIFIED CHECK OR BID BOND

Certified check or bid bond in the amount of:

_____ on
State Amount

Name of Bank or Bonding Company

_____ deposited herewith.

BIDDER

All bids not in conformity with these provisions will be rejected.

* *PLEASE PLACE BID BOND/CERTIFIED CHECK ON TOP OF THE BID PACKET WHEN SUBMITTING YOUR BID. ALSO, PLEASE HAVE NOTED THE ADDRESS OF WHERE THE BID BOND/CERTIFIED CHECK IS TO BE RETURNED. THANK YOU FOR YOUR COOPERATION.*

CERTIFICATION OF OSHA COMPLIANCE

I, _____, hereby certify that _____
Company Official) (Company)
will comply with all Federal, State and City of Cuyahoga Falls statutes, ordinances, rules and
regulations regarding job site safety, including but not limited to the Occupational Safety and
Health Act while engaged in this project. I understand that a failure of _____
(Company)
or its subcontractors to follow any safety regulation will result in the city, in its sole discretion
issuing a stop work order on the project until the violation is cured. Failure to stop work when
so ordered by the City may result in the immediate termination of the Agreement by the City.
The City may, in its sole discretion, notify OSHA of any violation of safety regulations by the
Company or its subcontractors. All fines and penalties that may result from any violation will be
borne by the Company or its subcontractor.

Signature

Title

State of Ohio)
)ss
County of _____)

Sworn to before me and subscribed in my presence this _____ of _____,
20_____.

Notary Public
My Commission Expires: _____

[seal]

CERTIFICATION

I, _____ certify that
(Company Official)

_____ has posted in the workplace and distributed
(Company)
to all employees our Drug-Free Workplace Policy Statement, a copy of which is attached hereto.

I further certify that _____ has made information on alcohol
(Employer)
and drug abuse awareness available to all employees and will provide information on the
availability of counseling and referral services to any employee requesting such information.

(Official Signature and Title)

State of Ohio)
County of Summit)ss
)

Sworn to before me and subscribed in my presence this ____ day of _____, 20____.

Notary Public

[Seal]

In accordance with City of Cuyahoga Falls Ordinance No. 12-1990, passed January 22, 1990:

DRUG FREE WORKPLACE POLICY STATEMENT

_____ hereby notifies all employees of our policy
(Employer)
regarding drugs in the workplace.

Without exception, the unlawful manufacture, distribution, dispensing, possession or use of a controlled substance while in the workplace is strictly prohibited.

_____ requires that as a condition of employment,
(Employer)
any employee convicted of a drug violation occurring in the workplace must notify his or her employer within five (5) days after conviction.

Any employee found in violation of this policy is subject to appropriate personnel action, up to and including termination of employment. Continued employment may be conditioned upon successful completion of an acceptable drug rehabilitation program.

Any employee seeking information on drug or alcohol abuse awareness and the availability of counseling and referral services should contact:

(Name)

(Phone)

CERTIFICATION

I, _____ hereby certify that
(Company Official)

_____ has received, reviewed, and distributed the
(Company)

City of Cuyahoga Falls' policy regarding Sexual Harassment to all employees who will be working or involved with this project. I further certify that _____
(Company)

will indemnify the City of Cuyahoga Falls in any action brought against it alleging that an employee of _____ engaged in any conduct prohibited by the
(Company)

City's Sexual Harassment Policy while working or otherwise involved with this particular Project.

Signature

Title

State of Ohio)
)ss
County of _____)

Sworn to before me and subscribed in my presence this ____ day of _____, 20__.

Notary Public

My Commission Expires: _____

[Seal}

EQUAL EMPLOYMENT OPPORTUNITY

During the performance of this contract, the CONTRACTOR agrees as follows:

- a. The CONTRACTOR will not discriminate against any employee or applicant for employment because of race, creed, color, sex, national origin or handicap status. The CONTRACTOR will take affirmative action to ensure that applicants are employed and that employees are treated during employment without regard to their race, creed, color, sex, national origin or handicap status. Such action shall include, but not be limited to the following: Employment, upgrading, demotion or transfer; recruitment or recruitment advertising; layoff or termination; rates of pay or other forms of compensation; and selection for training, including apprenticeship.

The CONTRACTOR agrees to post in conspicuous places, available to employees and applicants for employment, notices setting forth the provision of this nondiscrimination clause.

- b. The CONTRACTOR will, in all applications or advertisements for employees placed by or on behalf of the CONTRACTOR, state that all qualified applicants will receive consideration for employment without regard to race, creed, color, sex, national origin or handicap status.
- c. The CONTRACTOR will cause the foregoing provisions to be inserted in all subcontractors for any work covered by this Contract so that such provisions will be binding upon each subcontractor, provided that foregoing provisions shall not apply to contractors or subcontracts for standard commercial supplies or raw materials.

NON-COLLUSION AFFIDAVIT

THIS AFFIDAVIT MUST BE EXECUTED FOR THE BID TO BE CONSIDERED.

STATE OF _____)

)

COUNTY OF _____)

I, _____, _____
(Name of party signing affidavit) (Title)

being duly sworn, do depose and say: that

(Insert names of all persons, firms, or corporations interested in the bid)

its agents, officers, or employees have not directly or indirectly entered into any agreement, participated in any collusions, or otherwise taken any action in restraint of free competitive bidding in connection with this proposal; and also that no member of the Council, head of any department or bureau, or employee therein, or any officer of the City of Cuyahoga Falls is directly or indirectly interested therein.

Signature

Title

Sworn to and subscribed before me this _____ day of _____, 20____.

Notary Public in and for

COUNTY OF _____

STATE OF _____

My commission expires _____

[SEAL]

Have you double-checked your bid?
Errors or omissions could result in your bid being declared informal.

PREVAILING WAGE CONTRACTOR RESPONSIBILITIES

This is a summary of prevailing wage contractors' responsibilities. For more detailed information, please refer to Chapter 4115 of the Ohio Revised Code.

General Information

Ohio's prevailing wage laws apply to all public improvements financed in whole or in part by public funds when the total overall project cost is fairly estimated to be more than the following:

"New" construction threshold for Building Construction:	\$250,000
"Reconstruction, enlargement, alteration, repair, remodeling, renovation or painting" threshold for Building Construction:	\$75,000

OR

As of January 1, 2020:

"New" construction that involves roads, streets, alleys, sewers, ditches and other works connected to road or bridge construction threshold level has been adjusted to:	\$93,292
"Reconstruction, enlargement, alteration, repair, remodeling, renovation or painting" that involves roads, streets, alleys, sewers, ditches and other works connected to road or bridge construction threshold has been adjusted to:	\$27,950

- a. Thresholds are to be adjusted biennially by the administrator of Ohio Bureau of Employment Services.
- b. Biennial adjustments to threshold levels are made according to the Building Cost for Skilled Labor Index published by McGraw-Hill's Engineering News-Record, but may not increase or decrease more than 3% for any year.

Penalties for Violation

If an intentional violation is determined to have occurred, the Contractor is prohibited from contracting directly or indirectly with any public authority for the construction of a public improvement. Intentional violation means “a willful, knowing, or deliberate disregard for any provision” of the prevailing wage law and includes but is not limited to the following actions:

- a. Intentional failure to submit payroll reports as required, or knowingly submitting false or erroneous reports.
- b. Intentional misclassification of employees for the purpose of reducing wages.
- c. Intentional misclassification of employees as independent contractors or as apprentices.
- d. Intentional failure to pay the prevailing wage.
- e. Intentional failure to comply with the allowable ratio of apprentices to skilled workers as required by the regulations established by Ohio Bureau of Employment Services Wage and Hour Division.
- f. Intentionally employing an officer of a contractor or subcontractor that is known to be prohibited from contracting, directly or indirectly, with a public authority.

Responsibilities

A. Pay the prevailing rate of wages as shown in the wage rate schedules issued by the Ohio Bureau of Employment Services, Wage and Hour Division, for the classification of work being performed.

1. Wage rate schedules include all modifications, corrections, escalations, or reductions to wage rates issued for the project.
2. Overtime must be paid at time and one-half the employee’s base hourly rate. Fringe benefits are paid at straight time rate for all hours including overtime.
3. Prevailing wages must be paid in full without any deduction for food, lodging, transportation, use of tools, etc.; unless, the employee has voluntarily consented to these deductions in writing. The public authority and the Director of OBES Wage and Hour Division must approve these deductions as fair and reasonable. Consent and approval must be obtained before starting the project.

B. Use of Apprentices and helpers cannot exceed the rations permitted in the wage rate schedules.

1. Apprentices must be registered with the U.S. Department of Labor Bureau of Apprenticeship and Training.
2. Contractors must provide the Prevailing Wage coordinator a copy of the Apprenticeship Agreement for each apprentice on the project.

- C. Keep full and accurate payroll records available for inspection by any authorized representative of the Ohio Bureau of Employment Services or the contracting public authority, including the Prevailing Wage Coordinator. Records should include but are not limited to:
1. Time cards, time sheets, daily work records, etc.
 2. Payroll ledger/journals and cancelled checks/check register.
 3. Fringe benefit records must include program name, address, account number, and cancelled checks.
 4. Records made in connection with the public improvement must not be removed from the State for one year following the completion of the project.
 5. Out-of-State Corporations must submit to the Ohio Secretary of State the full name and address of their Statutory Agent on Ohio.
- D. Prevailing Wage Rate Schedule must be posted on the job site where it is accessible to all employees.
- E. Prior to submitting the initial payroll report, supply the Prevailing Wage Coordinator with your project dates to schedule reporting of your payrolls.
- F. Supply the Prevailing Wage Coordinator a list of all subcontractors including the name, address, and telephone number for each.
1. Contractors are responsible for their subcontractors' compliance with requirements of Chapter 4115 of the Ohio Revised Code.
- G. Before employees start work on the project, supply them with written notification of their job classification, prevailing wage rate, fringe benefit amounts, and the name of the Prevailing Wage Coordinator for the project. Copy of the completed signed notification should be submitted to Prevailing Wage Coordinator.
- H. Supply all subcontractors with the Prevailing Wage Rates and changes.
- I. Submit certified payrolls within two (2) weeks after the initial pay period. Payrolls must include the following information:
1. Employee's names, addresses, and social security numbers.
 - a. Corporate officers/owners/partners and any salaried personnel who do physical work on the project are considered employees. All rate and reporting requirements are applicable to these individuals.
 2. Employee's work classification.
 - a. Be specific about he laborers and/or operators.
 - b. For all apprentices, show level/year and percent of journeyman's rate
 3. Hours worked on the project for each employee.
 - a. The number of hours worked in each day and the total number of hours worked each week.
 4. Hourly rate for each employee.
 - a. The minimum rate paid must be the wage rate for the appropriate classification. The Department's Wage Rate Schedule sets this rate.

- b. When the amount contributed to the fringe benefit is documented but not the total hours worked, the hourly amount is calculated by dividing the total yearly contribution by 2080.
 - 5. Where fringes are paid into a bona fide plan instead of cash, list each benefit and amount per hour paid to program for each employee.
 - a. When the amount contributed to the fringe benefit plan and the total number of hours worked by the employee on all projects for the year are documented, the hourly amount is calculated by dividing the total contribution of the employer by the total number of hours worked by the employee.
 - b. When the amount contributed to the fringe benefit is documented but not the total hours worked, the hourly amount is calculated by dividing the total yearly contribution by 2080.
 - 6. Gross amount earned on all projects during the pay period.
 - 7. Total deductions from employee's wages.
 - 8. Net amount paid.
- J. The reports shall be certified by the contractor, subcontractor, or duly appointed agent stating that the payroll is correct and complete: and that the wage rates shown are not less than those required by the O.R.C. 4115.
- K. Send a Final Affidavit to the Prevailing Wage Coordinator upon the completion of the project.

COMPLETION TIME CERTIFICATION

The Contractor shall state the number of calendar days necessary for completion of this Contract after the date of Award of Contract.

Number of calendar days for _____ : _____ days.
(Name of Contract)

Signature of Bidder

Witness: By: _____

Address: _____

LOCAL BID PREFERENCE

The City of Cuyahoga Falls shall apply a Local Bid Preference to this invitation as outlined in Section 181.08 of the Codified Ordinances, including:

- a) In determining the low bid for supplies, commodities, materials, equipment, furnishings or general services, the Board of Control shall exercise a preference for local bidders as provided herein. The local preference shall also apply to contracts for the building, repair or renovation of public buildings or improvements.
- b) Bidders having established their principal place of business, defined as a business with a significant economic and physical presence in Cuyahoga Falls for two (2) successive calendar years prior to the bid opening date, shall be preferred as lowest if their bid does not exceed by more than three percent (3%), with an upper limit of ten thousand dollars (\$10,000.00), the apparent lowest bid.
- c) To qualify for local preference, bidders shall state on the bid documents their principal place of business, the business address where work will be administered (post office boxes will not be accepted in lieu of a street address) and the date of establishment. Each bidder shall have only one principal place of business.
- d) Local preferences shall not be applied as provided; herein for any bids where prohibited by federal or state laws or regulations.
- e) Local preferences shall only be applied in considering the lowest bid and shall not waive or nullify evaluation of which bidders are responsive and responsible. In no event shall any preference granted herein exceed a maximum of three percent (3%) or ten thousand dollars (\$10,000.00), whichever is less.
- f) The City shall indicate in all its invitations to bid and specifications for all public contracts for supplies, equipment and materials, excluding construction contracts and contracts financed in whole or in part by contributions or loans from any agency of the State of Ohio or United States Government, that it shall apply a local bid preference as outlined in this section in the evaluation and award of bids received.

Principal Place of Business:

Street Address	City	State	Zip
----------------	------	-------	-----

Address where work will be administered:

Street Address	City	State	Zip
----------------	------	-------	-----

Date Business Established (MM/DD/YYYY):

Findings of Recovery by Auditor of the State

Ohio law (ORC section 9.24) prohibits any state agency or political subdivision from awarding a contract for goods, services, or construction to any person against whom a finding for recovery has been issued by the Auditor of State, if that finding is unresolved. While there are additional criteria, the statute limits this prohibition to contracts which are paid in whole or in part with state funds and which exceed \$25,000.

The Auditor of State has established a database pursuant to ORC 9.24 in order to list all persons who have unresolved findings for recovery, dating back to January 1, 2001. Before entering into a public contract described above, a state agency or political subdivision is required to verify that the person does not appear in this database.

Each bidder shall log on to <http://www.auditor.state.oh.us/> and **provide a copy of a certified search of unresolved findings with your bid.** This requirement shall apply to all contracts awarded by the City of Cuyahoga Falls.

CERTIFICATION

I, _____ hereby certify that
(Company Official)

_____ does not have an unresolved finding of
(Company Official)

recovery issued by the Auditor of the State of Ohio as required by Ohio law (ORC section 9.24).

I further certify that _____ has provided a certified search of
(Company Official)

unresolved findings with this bid showing no unresolved findings in his/her name.

Signature

Title

State of Ohio)
)ss
County of _____)

Sworn to before me and subscribed in my presence this _____ day of _____, 20____.

Notary Public

My Commission Expires: _____

[Seal]

CERTIFICATION OF COMPLIANCE WITH O.R.C. 3517.13

The following certificates are required pursuant to Ohio's Campaign Finance Reform law.

One of the following two certificates shall be completed by any individual, partnership, unincorporated business, association, professional association, estate, trust, corporation, or business trust that has been awarded a contract by the City of Cuyahoga Falls.

It shall be the Contractor's responsibility to determine which of the two certificates applies and if compliance with R.C. 3517.13 has been achieved.

SPECIFICATIONS AND PROPOSALS

Section 4

PROPOSAL

DATE: _____

TO THE DIRECTOR OF PUBLIC SERVICE
CITY OF CUYAHOGA FALLS, OHIO

The undersigned proposes to:

Replace and/or repair concrete sidewalks, curbs/ramps and drive approaches at various locations in the City of Cuyahoga Falls

all in accordance with the plans and specifications for the City of Cuyahoga Falls, Ohio.

The quantity in the column headed "ESTIMATED QUANTITY" is that which will be used in determining the total amount of the proposal for the purpose of determining the lowest bidder; but it is understood and agreed that this quantity is APPROXIMATE ONLY and that the Contractor to whom the Contract is awarded shall not be entitled to any claim for the loss of profits, or for other damages should the quantity prove to be greater or less than is herein given in said "ESTIMATED QUANTITY" column.

In the event that the amounts entered into the columns labeled "UNIT COST LABOR" and "UNIT COST MATERIAL" are inconsistent with the amounts entered in the column labeled "TOTAL UNIT COST", the bidder agrees that the amounts entered in the "UNIT COST LABOR" and "UNIT COST MATERIAL" shall control.

The bidder agrees further that if this proposal be accepted he will contract with the City to perform the work as outlined in the specifications in accordance with a work schedule that is agreeable to the Director of Public Service all for the following prices:

COMPANY

BY: _____

TITLE

ADDRESS

Zip Code

Phone

BASE BID 2021 SIDEWALK, CURB/RAMP DRIVE APPROACH PROGRAM

ITEM NO.	SPEC. REF.	ITEM DESCRIPTION	UNIT MEASURE	ESTIMATED QUANTITY	UNIT COST LABOR	UNIT COST MATERIAL	TOTAL UNIT COST	TOTAL COST	TOTAL AMOUNT WRITTEN OR TYPED WORDS
1	203	Excavation Tree Root Removal / Lawn strip Grading	C.Y.	200					
2	203	Embankment Tree Root Removal / Lawn strip Grading	CY	200					
3	301	#301 Asphalt base for Patching	Ton	30					
4	304	#304 Crushed Limestone for Driveways	Ton	28					
5	448	#448 Surface Asphalt for Patching	Ton	35					
6	611	3" PVC Downspout	L.F.	1100					
7	611	Adjusting Storm Inlet Casting	Each	3					
8	611	Reconstruct Catch Basin Curb Inlet	Each	1					
9	608	Rem & Repl 4" & 6" Conc. Sidewalk Complete	SF	20000					
10	608	Construct ODOT Curb Ramps Complete	SF	600					
11	608	Rem & Repl 6" Conc. Aprons Class C Concrete	SF	2200					
12	608-spec	Integral Concrete Curb & Sidewalk Complete	SF	100					
13	609	Rem & Repl Conc. Curb Complete	LF	600					
14	624	Mobilization	Lump	1					
15	660	Sod	SY	75					
16	SPEC.	Horizontal Saw Cutting (Curb Cuts)	LF	25					

Unofficial Total Base Bid

\$ _____

4.1.1*

RESOURCES AND EXPERIENCE OF BIDDER

THE BIDDER, in order to secure consideration of this proposal, shall complete the following:

A. State below work performed similar to that to be done under this proposed contract:

B. State below the larger items of owned equipment proposed for use under this proposed contract:

C. Submit evidence of financial ability to handle the work under this proposed contract. A statement such as "Adequate" will not be accepted by the Board of Control.

NOTE: NO PROPOSAL WILL BE CONSIDERED UNLESS THE ABOVE IS COMPLETED.

QUALIFICATION INFORMATION

The information contained herein is for the guidance of the Board of Control in awarding the Contract and will be regarded as confidential.

The undersigned bidder proposes to use the following entirely owned equipment on this project:

The undersigned bidder proposes to use the following rented equipment on this project:

The undersigned bidder agrees to maintain all owned or rented equipment used on this project in a workable and safe condition and further agrees that the director of public service (or a designee) shall have the right to inspect said equipment at any reasonable time.

THE UNDERSIGNED BIDDER HAS CONTRACTED WITH THE FOLLOWING GOVERNMENTAL AGENCIES FOR WORK OF A SIMILAR NATURE:

	LOCATION & TYPE	AGENCY	DATE (S)	\$ VALUE
1				
2				
3				
4				
5				

COMPANY

SIGNATURE

PRINT NAME AND TITLE

NOTICE OF SUBCONTRACTORS

Name of Bidder: _____

If you intend to have any portion of this contract performed by a subcontractor, list the subcontractor(s) below:

If you are the successful bidder, you will be fully responsible to the City of Cuyahoga Falls for the acts and omissions of all subcontractors, supplies and other persons performing or furnishing any portion of this contract. In addition, you must ensure that any warranties provided by or through any subcontractor, supplier, or other person are to the benefit of and enforceable by the City of Cuyahoga Falls, Ohio.

Acknowledged by:

Authorized Agent of Bidder

ATTENTION ALL BIDDERS

ATTENTION OF THE BIDDER is directed to general information relating to the PROPOSAL contained herein, all of which work shall be performed in accordance with the **Current Specifications for the City of Cuyahoga Falls** and any **Special Specifications** contained herein applicable to these improvements.

CURRENT CONSTRUCTION SPECIFICATIONS: (1976 Edition)

Bidders who do not have a copy of these specifications may obtain same from the office of the City Engineer at a cost of twenty dollars (\$20.00) per copy.

SPECIAL PROVISIONS:

This section of the Proposal contains any Addenda's, Supplemental Specifications and Special Specifications applicable to these improvement and should be carefully reviewed by the Bidder. (This section follows the Proposal of bid items).

QUALIFICATION INFORMATION:

This page follows the Proposal of Items of Work and shall be filled in by the bidder to be used by the Board of Control as a guide in awarding this contract. This information will NOT be read at the bid opening.

AWARD OF CONTRACT BY THE BOARD OF CONTROL:

The BOARD OF CONTROL proposes to award the contract for this Proposal based upon the summation of the individual total bid prices, however, the BOARD OF CONTROL reserves the right to REJECT ANY AND ALL BIDS.

LOCAL BID PREFERENCE

The City of Cuyahoga Falls shall apply a Local Bid Preference to this invitation as outlined in Section 181.08 of the Codified Ordinances.

LAWN RESTORATION

- 1) Perform lawn restoration and seeding work only after other work affecting ground surfaces have been completed. All existing lawn areas disturbed by the installation of this project shall be re-seeded to establish new lawn in these areas.
- 2) The Contractor shall be responsible for removal of all site debris, fine grading of the disturbed areas with four-inches (4") of new, clean, screened topsoil, and seeding new lawn areas with Fairlawn Brand Seed (Oliger) or equal at a rate of 5 lbs. per 1000 square feet.
- 3) To insure quick establishment of lawn areas the Contractor will apply Mil-Chem organic fertilizer (12-16-10) or approved equal at a rate of 40 lbs. per 5000 square feet and then install shredded wheat straw held in place with tackifier or green netting.
- 4) Seed shall be Fairlawn Brand as distributed by Oliger Seed or approved equal. Seed shall be clean and fresh, packed in sealed bags showing net weight, composition of mix, date of germination tests and supplier's name. Germination test shall be done within a nine (9) month period prior to sale of the seed.
- 5) Fertilizer shall be a granular, non-burning product composed of not less than 50% organic, slow acting, guaranteed analysis professional fertilizer. Included shall be starter fertilizer containing 13% nitrogen, 25% phosphoric acid and 12% potash by weight or approved similar composition.
- 6) Clean topsoil shall not contain glass, rocks, twigs, leaves or other unsuitable material. All topsoil shall be screened.

ATTENTION

GENERAL CONTRACTORS

PUBLIC IMPROVEMENT CONTRACTS ARE AWARDED BY THE BOARD OF CONTROL TO A GENERAL CONTRACTOR WHO IS ENTIRELY RESPONSIBLE TO THE CITY OF CUYAHOGA FALLS FOR THE WORK UNDER THE TERMS OF THE PROPOSAL CONTAINED HEREIN.

SUB-CONTRACTORS WORK DIRECTLY FOR THE GENERAL CONTRACTOR, WITH WHOM ALL PROBLEMS SHALL BE DISCUSSED, AND NO CONTACT SHALL BE MADE WITH THE DIVISION OF ENGINEERING EXCEPT THROUGH OR IN THE PRESENCE OF THE GENERAL CONTRACTOR.

PAYMENTS FOR THE WORK ARE MADE DIRECTLY TO THE GENERAL CONTRACTOR.

SPECIFICATION ADDENDUM

SECTIONS 109.08 & 109.09

109.08 Final Estimate

Before the final estimate is allowed, the Owner shall require the Contractor to submit an affidavit from each and every subcontractor showing that all claims and obligations arising in connection with the performance of his portion of the contract have been satisfactorily settled. The improvement shall be inspected by the Engineer, and if he finds the Work is completed according to the contract, shall, within 60 days after the completion of this contract, prepare a statement of the total cost of the Work done hereunder, and the Owner shall pay the entire sum so found to be due hereunder after deduction therefrom all previous payments under the provisions of this contract and ALSO DEDUCTING THE GUARANTEE AND RETAINAGE CHARGE AS SET FORTH IN SECTION 109.09 following.

109.09 Guarantee and Retainage

The Contractor shall guarantee all Materials and Equipment furnished and work performed for a period of one (1) year from the date of completion. The Contractor warrants and guarantees that the completed system is free from all defects due to faulty materials or workmanship and the Contractor shall promptly make such corrections as may be necessary by reason of such defects including the repairs of any damage to other parts of the system resulting from such defects. The Owner will give notice of observed defects with reasonable promptness. In event that the Contractor should fail to make such repairs, adjustments, or other work that may be made necessary by such defects, the Owner may do so and charge the Contractor the cost thereby incurred. The Performance Bond shall remain in full force and effect through the guarantee period.

Further the City will retain three percent (3%) of the entire cost of the work done by the Contractor for the above guarantee period of one year beginning on the date of the Engineer's final estimate payment sheet.

If the Contractor shall have complied with all the requirements of the contract in keeping said improvement in good and proper repair, at the end of his guarantee period upon order of the director the Contractor shall receive this retainer; but, if the Contractor shall fail to make all necessary repairs as indicated by said Engineer at any time during the above period, then the Engineer shall have power to expend all or such part of the amounts so retained as the said Engineer may see fit, and apply the same to making the necessary repairs.

Should the amount retained not be sufficient to make the required repairs, the contractor shall at once make good the deficiency. At the expiration of the guarantee period as above specified, whatever remains to the credit of the Contractor, provided all repairs shall have been made satisfactory to the said Engineer, shall be paid to the Contractor as full settlement of any balance due on said contract as herein provided whereupon and not until then, shall the Contractor be released from the obligation assumed in this contract and his bond discharged. The final acceptance of the work shall be the date when the guarantee is released.

SPECIFICATION ADDENDUM

SECTION 109.06

109.06 Partial Payments

(a) At least ten (10) days before each progress payment falls due (but not more often than once a month), the Contractor will submit to the Engineer a partial payment estimate filled out and signed by the Contractor covering the Work performed during the period covered by the partial payment estimate and supported by such data as the Engineer may reasonably require. If payment is requested on the basis of materials and equipment not incorporated in the Work but delivered and suitably stored at the site, the partial payment estimate shall also be accompanied by supporting data, as follows: 1) waiver of lien, 2) proper invoice for material, 3) assurance of City's title to material, 4) proof of payment to vendor for material, 5) proof of applicable insurance on material is in effect. Payment for material stored on site shall be limited to major items of construction with a value exceeding one percent (1%) of contract value. The Engineer will, within ten (10) days after receipt of each partial payment estimate, either indicate in writing his approval of payment and present the partial payment estimate to the Owner, or return the partial payment estimate to the Contractor indicated in writing his reasons for refusing to approve payment. In the latter case, the Contractor may make the necessary corrections and resubmit the partial payment estimate. The Owner will, within thirty (30) days of presentation to him of an approved partial payment estimate, pay the Contractor a progress payment on the basis of the approved partial payment estimate. The Contractor will be paid the bid and stipulated unit and lump sum prices as set forth in his Proposal, for the amount of work approved for payment by the Engineer. The sum total for these items shall constitute full payment for the job complete, tested, and ready for use.

(b) The Owner shall retain ten percent (10%) of the amount of each partial payment until the work is complete. With the final payment the Owner shall pay the Contractor seventy percent (70%) of the retainage held.

Ord. 56-1990
4/9/90

GENERAL CONTRACTORS

IMPROVEMENT CONTRACTS FOR CURBING, PAVING, RESURFACING

THE CONTRACTOR TO WHOM THIS CONTRACT HAS BEEN AWARDED SHALL COMPLY WITH THE REQUIREMENTS OUTLINED HEREIN:

1. PLANS AND STANDARD DRAWINGS:

Prints shall be on the job and available at all times.

2. CONCRETE WORK INVOLVING FORM WORK:

No concrete work shall be placed until form work has been approved and accepted by the City Project Inspector.

Concrete work constructed in violation of this directive shall be subject to removal and replacement at the expense of the Contractor.

3. UNDERGROUND ELECTRIC AND COMMUNICATION WIRES, CONDUIT AND APPURTENANCES:

The Contractor shall be responsible for any damages.

4. LOCATION OF DOWN SPOUT DRAINS:

The Contractor shall be responsible for the location of all down spout drains. If a drain is inadvertently overlooked and it is necessary to drill a hole in the curb after it has been placed, the drilling shall be performed by the City's contractor at the expense of the Contractor.

5. LOCATING OF WATER SERVICE BOXES, WATER SHUT-OFF VALVE BOXES, AND SANITARY AND STORM SEWER MANHOLES:

The initial locating of these boxes and manholes will be performed by the City Water Utilities Department forces upon a one (1) week notice.

It will then be the responsibility of the Contractor to preserve the location stakes or log the points by another method. If it is necessary for the City Water Utilities Department forces to relocate these items, costs will be billed at the prevailing hourly rate at which the work is performed.

6. ADJUSTING WATER SERVICE BOXES TO GRADE:

The top of these curb boxes shall be either flush with or a maximum of 1/4" below the surface of the berm, drive approach, or sidewalk. These boxes will be replaced prior to adjusting as determined by the City Engineer. The Contractor will ensure that each box is in good condition and that the stem is operational.

All damaged or buried service boxes must be corrected within two (2) weeks following written notification by the City. All costs incurred by the City to correct damaged or buried service boxes will be billed at the prevailing hourly rate at which the work is performed.

7. ADJUSTING WATER SHUT-OFF BOXES TO GRADE:

The top of these water boxes shall be either flush with or a maximum of 1/4" below the final surface of pavement, berm, drive approach, or sidewalk. Measurement in excess of these limits shall be grounds for non-acceptance of this item.

The boxes shall be adjusted prior to addition of the final asphalt surface course. Riser rings are acceptable for water boxes, provided the top section is in good condition. The boxes will be replaced prior to adjusting as determined by the City Engineer.

All boxes found damaged, covered, or buried must be corrected within two (2) weeks following written notification by the City. All costs incurred by the City to expose or correct damaged boxes will be billed at the prevailing hourly rate at which the work is performed, minus the bid amount for items not performed.

8. ADJUSTING SANITARY AND STORM SEWER FRAMES AND LIDS TO GRADE:

The top of the sanitary and storm sewer frames and lids shall be either flush with or a maximum of 1/4" below the final surface of pavement, berm, drive approach, or sidewalk. Measurement in excess of these limits shall be grounds for non-acceptance of these items.

The frames and lids shall be adjusted prior to addition of the final asphalt surface course. The frames shall be replaced prior to adjusting as determined by the City Engineer. Riser rings are not acceptable for adjusting sanitary and storm sewer lids to grade.

Care must be exercised to prevent debris from falling into the base of the manhole during removal, loosening installation or adjusting of these frames and lids. All debris must be removed immediately to prevent restriction of flow. All damage or work incurred by the City or residents due to a plugged sewer caused by debris from this work will be at the expense of the Contractor.

The Water Utilities Department will provide all frames and lids needed to replace defective items. NOTE: All two-inch (2") frames and lids are to be replaced with Cuyahoga Falls Standard one-inch (1") frames and lids. All frames and lids needed will be picked up by the Contractor following coordination with the Water Utilities Superintendent. All items replaced are the property of the City and will be picked up by City forces.

All manhole frames and lids found damaged or buried must be corrected within two (2) weeks following written notification by the City. All costs incurred by the City to expose or adjust manhole frames and lids will be billed at the prevailing hourly rate at which the work is performed, minus the bid amount for items not performed.

SPECIAL PROVISIONS

ADDENDAS AND SUPPLEMENTAL SPECIFICATIONS
TO THE CURRENT CONSTRUCTION SPECIFICATIONS FOR
THE CITY OF CUYAHOGA FALLS.

THIS SECTION ALSO INCLUDES ANY SPECIAL
SPECIFICATIONS AND STANDARD CONSTRUCTION
DRAWINGS APPLICABLE TO THIS PROPOSAL.

SECTION 5

NOTICE TO CONTRACTOR:

“DOMESTIC STEEL USE REQUIREMENTS AS SPECIFIED IN SECTION 153.011 OF THE REVISED CODE APPLY TO THIS PROJECT. COPIES OF SECTION 153.011 OF THE REVISED CODE CAN BE OBTAINED FROM ANY OF THE OFFICES OF THE DEPARTMENT OF ADMINISTRATIVE SERVICES.”

WORK SPECIFICATIONS

SIDEWALK/CURB REPLACEMENT PROGRAM

LOCATION OF WORK

The work shall be performed at various locations within the City of Cuyahoga Falls. Locations are distributed randomly throughout the City.

SCOPE OF WORK

The Contractor shall furnish tools, equipment, materials, labor and services for the complete removal and construction of sidewalk, various curbs, ramps and all construction necessary and associated therewith.

The work shall include but not be limited to the following:

- 1) Removal of sidewalk, various curb, drive approach and appurtenances at locations specified by the City Project Inspector.
- 2) The forming, pouring and finishing of sidewalk, various curbs drive approach & ramps at locations that had been removed.
- 3) Restoration of lawn areas, trees, fences, streets or any appurtenance located in adjacent areas damaged by performance of the above work.
- 4) Excavation, installation and backfilling of water valve boxes located in removed sidewalk as directed by the City Project Inspector.
- 5) Patching of existing concrete driveways with new concrete to meet replaced concrete.
- 6) Asphalt appurtenances abutting against sidewalk shall be patched with ODOT Specification 448 Hot Mix Asphalt to make a smooth transition between asphalt and concrete.
- 7) Replacement and installation of house drains. This will include securely hooking the new drain up to existing drains with a watertight connection.
- 8) Construction of New Sidewalk, Per ODOT Specification 608 Walks, Curb Ramps and Steps
- 9) Prepare base, Per ODOT Specification 203 Roadway Excavation and Embankment for drive approach, new sidewalks, and various curbs.

SUPPLEMENTAL GENERAL SPECIFICATIONS

SIDEWALK / CURB REPLACEMENT PROGRAM

The City of Cuyahoga Falls is soliciting bids for sidewalk, drive approach and various curb construction and/or replacement. The City shall award a contract or contracts based upon the lowest and best combination of bid prices.

The contract shall be awarded to a single contractor.

The successful contractor shall provide all necessary MSDS sheets on all applicable materials used in his operations.

SUPPLEMENTAL SPECIFICATIONS
SIDEWALK/ CURB REPLACEMENT PROGRAM

1. **Excavation Item 203** shall consist of grading city lawn strip to conform to new city sidewalk grade so as to allow drainage of sidewalk and city lawn strip. Work shall consist of but not be limited to the removal of tree roots, sod and dirt.
2. **Embankment Item 203** shall consist of placing and compacting approved material within the city lawn strip where unsuitable materials has been removed and conform to new city sidewalk grade so as to allow drainage of sidewalk and city lawn strip.
3. **Sidewalk Item 608** shall include the cost of saw cutting, excavating, removing subbase where specified, placing granular fill, compacting the subgrade, forming, finishing, cure, topsoil, seed and mulch.
4. **Curb Ramps Item 608** shall be constructed as per attached plans, be paid per square foot. The square foot cost shall include the cost of saw cutting, excavation, forming, placing, finishing, truncated domes, placing of truncated domes, cure, topsoil, seed and mulch within the shaded area. (See Revised ODOT Drawing BP-7.1, New Curb Ramps, Revised 7-17-2020).
5. **Item 608-Spec** shall be constructed as per attached detail, be paid per square foot. The square foot cost shall include the cost of saw cutting, excavating, removing subbase where specified, placing granular fill, compacting the subgrade, forming, finishing, cure, backfilling, topsoil, seed and mulch.
6. **Curbing Item 609** shall include the cost of saw cutting, excavating, removing subbase where specified, placing granular fill, compacting the subgrade, forming, finishing, cure, backfilling, topsoil, seed and mulch.
7. Removal of existing sidewalk, drive approach, curb and curb ramps shall be included in the cost per unit price of sidewalk, drive approach, curb and curb ramp.
8. **Item 624, "Mobilization."** The Contractor shall provide and maintain to the City Inspector a cell phone with a **local phone number area code to be (330)** and a cell phone charger to be used for the duration of the project. Along with 3 cases of inverted marking paint with an applicator. The cost of these items shall be considered incidental to **Item 624, "Mobilization."**
9. Detectable warnings (truncated domes) shall be installed per enclosed ODOT typical drawings. Polyethylene inserts shall be used in place of the brick style units. The city shall select color.
10. Any damage to streets, lawn areas, sidewalks, curbs, trees, shrubs or fences caused by the Contractor in the performance of the work shall be repaired or otherwise corrected at the expense

SUPPLEMENTAL SPECIFICATION cont'd.

of the Contractor and shall be done to the satisfaction of the City Project Inspector. All sidewalk shall be poured the same day of removal. Complete restoration of the job site shall be completed by the Friday following removal of the sidewalk. Liquidated damages shall be assessed against the Contractor, based upon the contract total, for each day beyond the above limits (either and/or both) that the work is not completed, per ODOT Specification 108.07.

11. The City Project Inspector reserves the right to add or delete sidewalk, drive approach and curb to be replaced. This includes the addition of quantities at the end of the contract with no prior warning.
12. The Contractor shall be responsible for traffic control per OMUTCD.
13. **Drains Item 603** The linear foot price of drain pipe shall include the proper watertight fittings to attach the pipe to the pre-existing drain at the back of the walk, installation under the walk and the installation of pipe from the front of the walk to the edge of the street and property marking of pipe location as directed by the City Project Inspector.
14. Sidewalk across drive approaches shall be six-inches (6") thick and paid for at the same square foot price as all other sidewalk.
15. Sidewalk and curb across drive approaches shall be poured on the same day as it is removed. Liquidated damages shall be assessed against the Contractor, based upon the contract total, for each day beyond the above limit that the work is not completed, per ODOT Specification 108.07.
16. Access shall be maintained for commercial drive approaches. This will be accomplished by either removing and pouring the curb and/or sidewalk in sections or placing steel plates across the excavation and newly poured concrete.
17. Expansion material shall be placed between sidewalk and existing approaches and existing driveways. It shall also be placed every fifty-feet (50') at the control joint.
19. Sidewalk shall receive a broom finish and be sprayed with latex curing compound.
20. Control joints for sidewalk shall be sawn every five-feet (5') and shall be straight, and perpendicular to the sides.
21. Control joints for curb shall be sawn every ten-feet (10') and shall be straight, and perpendicular to the sides.
22. When it is determined that tree roots shall be removed under sidewalk. Root removal shall be included and paid for at the same square foot price as all other sidewalk.

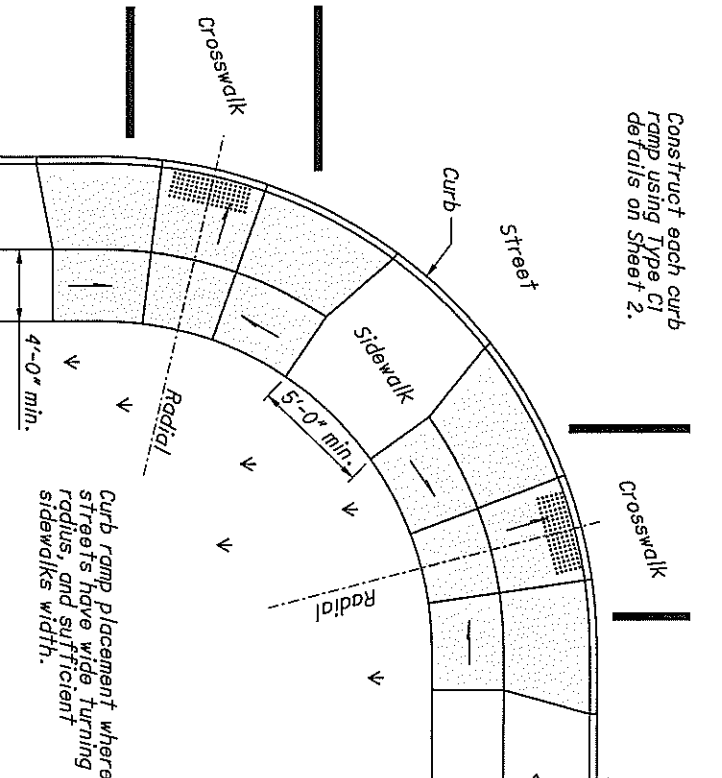
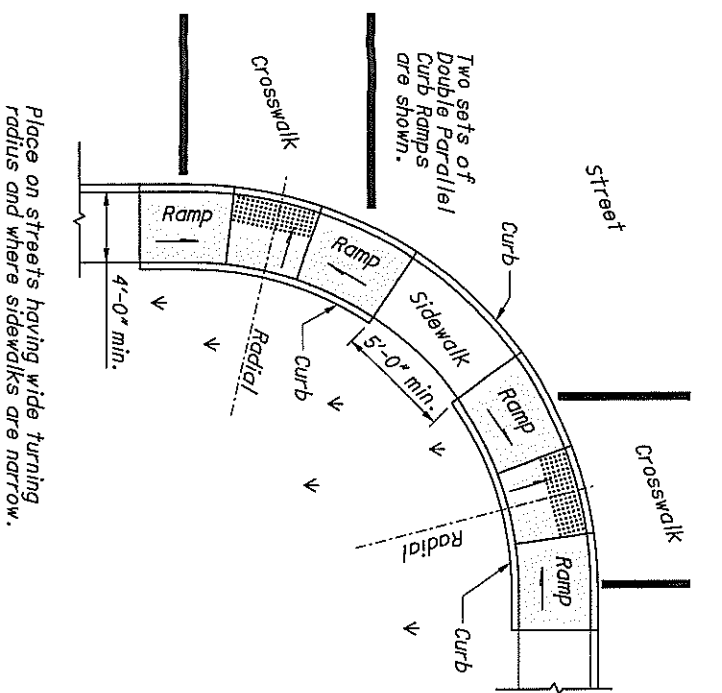
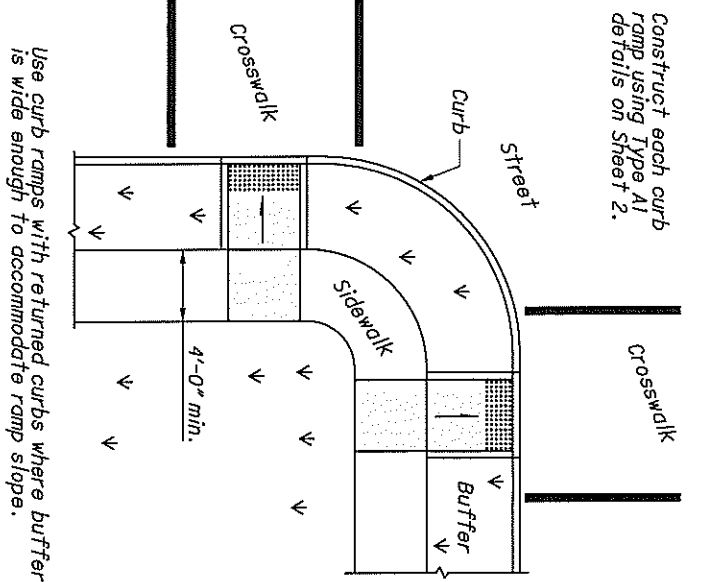
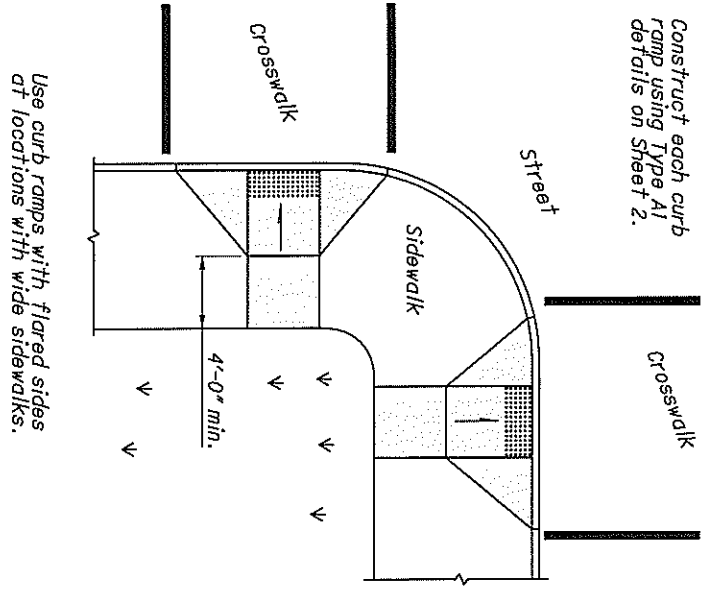

PERPENDICULAR CURB RAMPS

PREFERRED CONSTRUCTION PLACEMENT

PARALLEL CURB RAMPS

COMBINATION CURB RAMPS

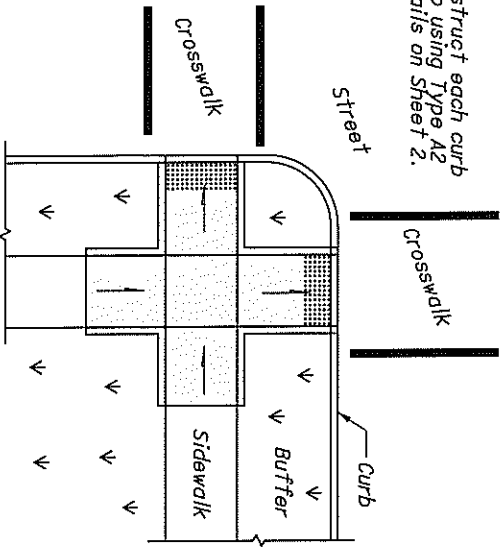

NOTES

GENERAL: This drawing shows curb ramp types details and placement examples for curb ramp construction, including the installation of detectable warnings.

Curb ramp types are shown on Sheet 2 and include Perpendicular, Parallel, and Combined types as specified to be constructed in the locations shown on the project plans.

Curb ramps added to an existing intersection or walk should be individually detailed on the project plans to assure that the design is appropriate for site constraints and all items can be constructed to ADA standards. The contractor may adjust the placement of curb ramps if existing field conditions warrant with the approval of the Engineer.

PAYMENT: Measure and pay for the ramp area within the shaded limits of this drawing as Item 608 Curb Ramp, Square Foot. This includes the cost of any curb or curb and gutter, detectable warnings, landing areas and any additional materials, installation, grading, forming, and finishing required within the shaded area.

Work beyond the shaded ramp/landing area is paid for as curb (609) and walk (608). Removal of existing curb, walk (or existing curb ramps) are paid under Item 202.

For at-grade crossing locations where only detectable warnings are required in order to achieve ADA compliance, measure and pay for the strip of detectable warnings as Item 608 Detectable Warning, Square Foot. The work to cast the tiles in place will also require removal of existing pavement (Item 202) to the nearest joint, or if no joint exists, a minimum of 4 feet.

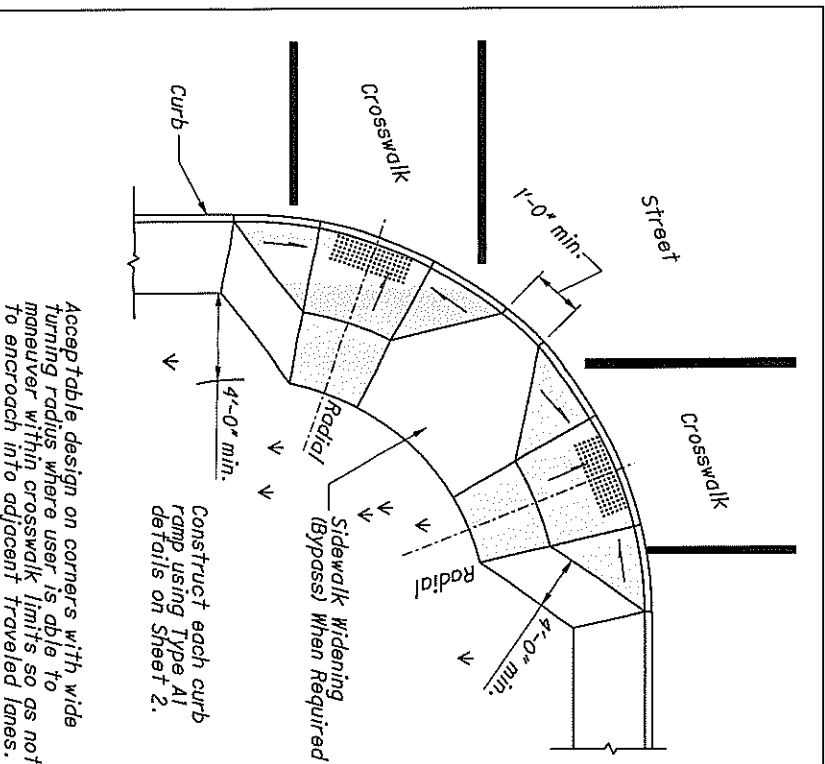

PERPENDICULAR RAMPS

ACCEPTABLE CONSTRUCTION PLACEMENT

DIAGONAL RAMP (Type D)

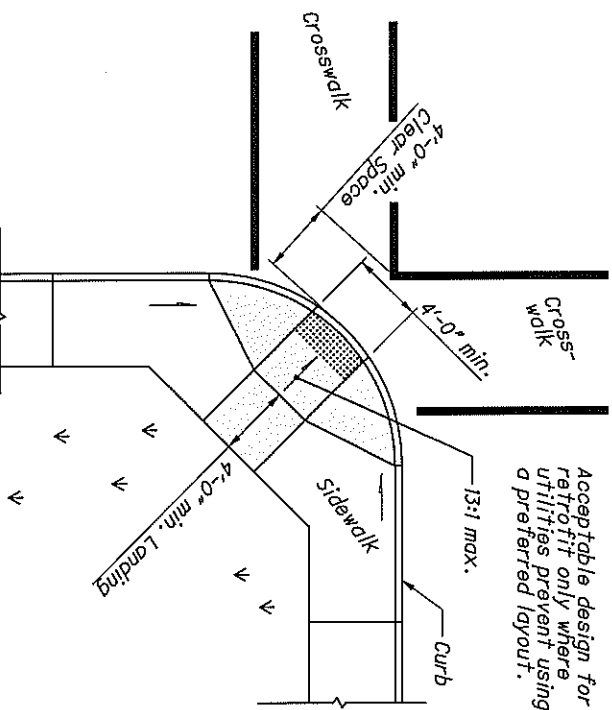

THIS DRAWING REPLACES BP-7.1 DATED 7-20-2018.

SCD NUMBER BP-7.1	STANDARD ROADWAY CONSTRUCTION DRAWING NEW CURB RAMPS (with Detectable Warnings)	OFFICE OF ROADWAY ENGINEERING	STDS. ENGINEER D. Fisher	STATE OF OHIO DEPARTMENT OF TRANSPORTATION ADMINISTRATOR Brenton Bogard	REVISION DATE 7-17-2020
-----------------------------	--	---	--------------------------------	---	----------------------------

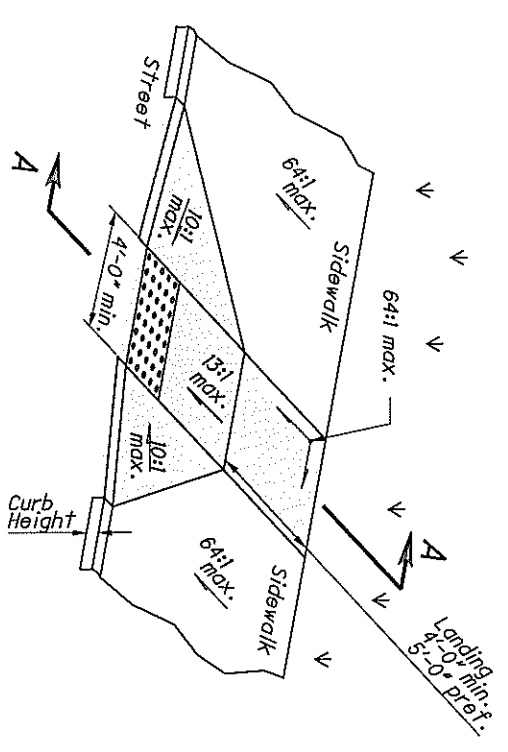

Type A1 (Perpendicular with flared sides)
PERPENDICULAR CURB RAMP DETAILS

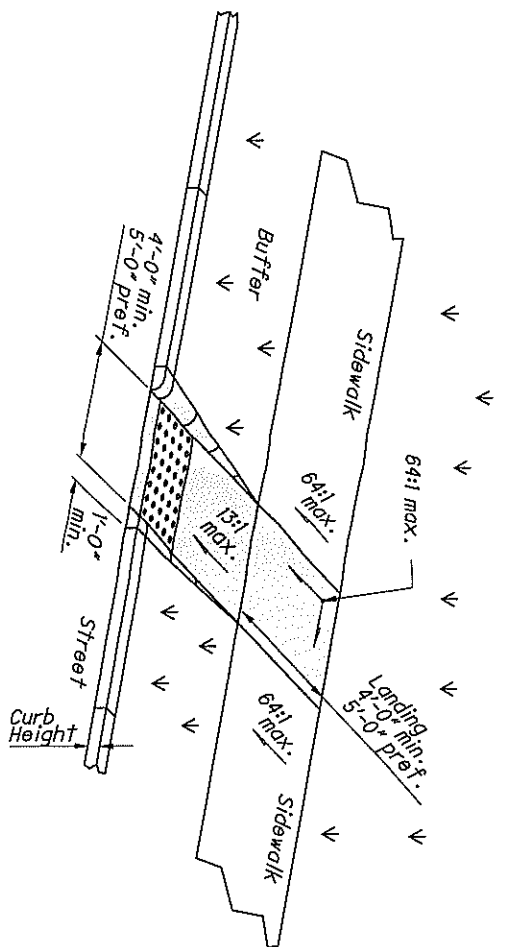

Type A2 (Perpendicular with returned curb)

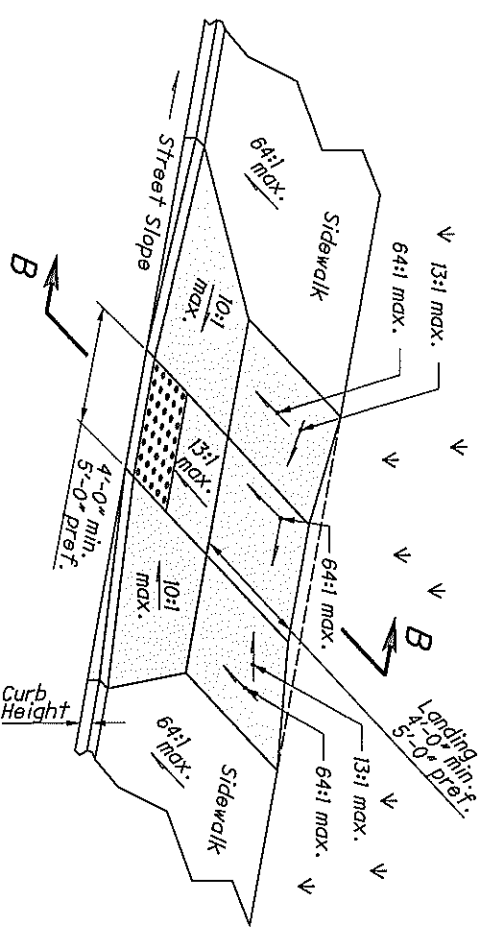

Type C1 (Combined with flared sides)
COMBINED CURB RAMP DETAILS

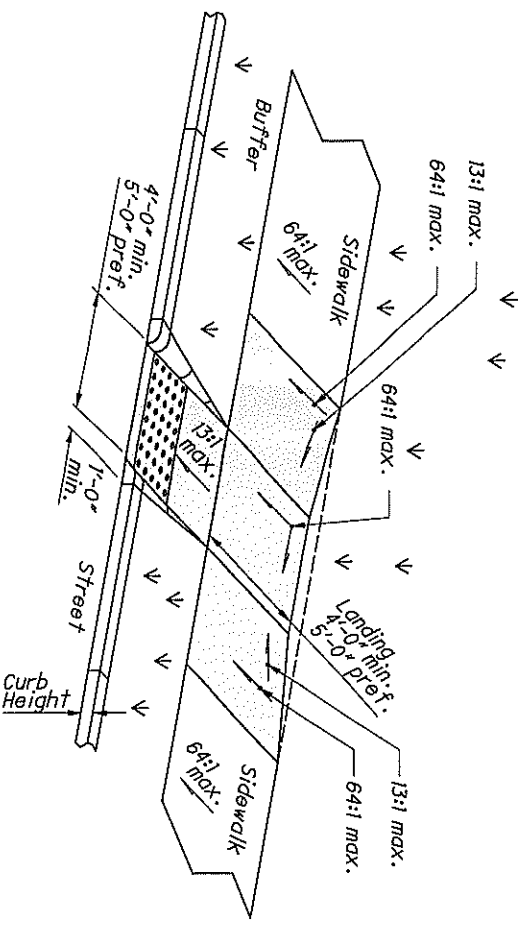

Type C2 (Combined with returned curb)

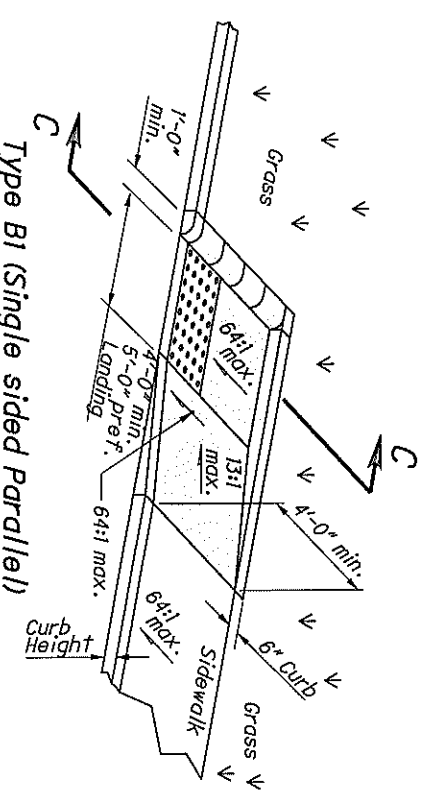

Type B1 (Single sided Parallel)
PARALLEL CURB RAMP DETAILS

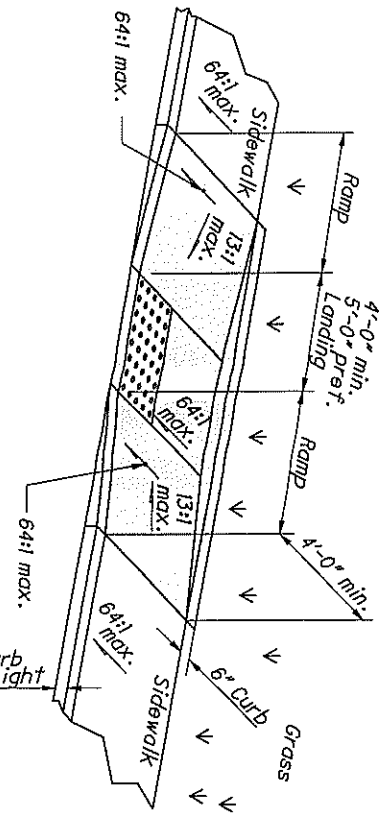

Type B2 (Double sided Parallel)
PARALLEL CURB RAMP DETAILS

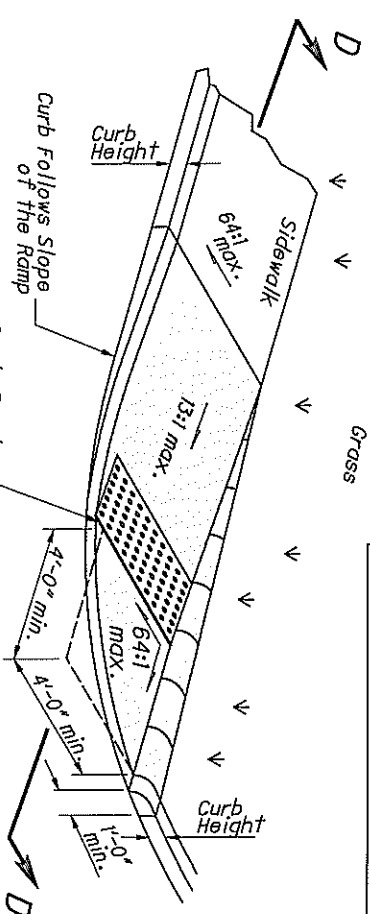

Type B3 (Single sided Parallel)
PARALLEL CURB RAMP DETAILS

NOTES CONTINUED

The running slope of the curb ramp shall be a 13:1 maximum or flatter. In existing sidewalks, where the maximum ramp slope is not feasible due to site constraints (e.g. utility poles or vaults, right-of-way limits) it may be reduced as follows:

- A) 10:1 for a max. rise of 6"
- B) 8:1 for a max. rise of 3"
- C) 6:1 over a max. run of 2'-0" for historic areas where a flatter slope is not feasible.

To prevent chasing the grade indefinitely, the transition from existing sidewalk to the shaded curb ramp area is not required to exceed 15 feet in length.

While ramps may be skewed to the crosswalk, the entire lower landing area must fall within the crosswalk that the ramp serves and cannot be located in the traveled lane of opposing traffic.

The counter slope of the gutter or street at the foot of a curb ramp, landing, or blended transitions shall be 20:1 or flatter.

The bottom edge of the ramp shall change planes perpendicular to the landing.

The edge of the curb shall be flush with the edge of the adjacent pavement and gutter and surface slopes that meet grade breaks shall also be flush.

Ramp landings shall be 4' min. x 4' min. with a 64:1 or flatter cross slope and running slope.

DETECTABLE WARNINGS: Install Detectable Warnings on each curb ramp with approved materials, as shown on Sheet 3. Install these proprietary products as per manufacturer's written instructions.

DRAINAGE: Contractor is to ensure the base of each constructed curb ramp allows for proper drainage, without exceeding allowable cross slope or ramp slopes. Vertical change in level exceeding 1/8" between the 1) pavement and gutter, and 2) gutter and ramp, are not allowed.

SURFACE TEXTURE: Texture concrete surfaces by coarse brooming transverse to the ramp slopes to be rougher than the adjacent walk.

JOINTS: Provide expansion joints in the curb ramp as extensions of walk joints and consistent with Item 608.03 requirements for a new concrete walk. Provide a 1/2" item 705.03 expansion joint filler around the edge of ramps built in existing concrete walks. Lines shown on this drawing indicate the ramp edges and slope changes, and do not necessarily indicate joint lines.

See Sheet 3 for Sections.

THIS DRAWING REPLACES BP-7.1 DATED 7-20-2018.

SCD NUMBER BP-7.1	STANDARD ROADWAY CONSTRUCTION DRAWING NEW CURB RAMPS (with Detectable Warnings)	OFFICE OF ROADWAY ENGINEERING	STOS. ENGINEER D. Fisher	STATE OF OHIO DEPARTMENT OF TRANSPORTATION ADMINISTRATOR Brenton Bogard	REVISION DATE 7-17-2020
-----------------------------	--	-------------------------------------	--------------------------------	---	----------------------------

PREVAILING WAGE

SECTION 6

INSTRUCTIONS FOR PREPARING CERTIFIED PAYROLL REPORTS

General:

Contractors and subcontractors are required by law to submit certified payroll reports for work on projects covered by Ohio's Prevailing Wage Law. This form meets the reporting requirements established by Ohio Revised Code Chapter 4115. The use of this form is not mandatory; employers may submit their own forms provided that all of the required information is included. This form may be reproduced, or additional copies obtained from:

Ohio Department of Commerce
Bureau of Wage and Hour Administration
6606 Tussing Road
Reynoldsburg, Ohio 43068 (614) 644-2239

Certified Payroll Heading:

Employer name and address: Company's full name and address. Indicate if the company is a subcontractor, if so; list the name of the General or Prime.

Project: Name and location of the project, including county.

Contracting Public Authority: Name and address of the contracting public authority.

Week Ending: Month, day, and year for last day of reporting period.

Payroll #: Indicates first, second, third, etc., payroll filed by the company for the project.

Page indicator: Number of pages included in the report.

Project Number: Determined by the public authority. If there is no number leave blank.

Payroll Information by column:

1. Employee Name, Address and Last Four Digits of Social Security Number: This information must be provided for all employees that perform physical labor on the project. Corporate officers, partners, and salaried employees are considered employees and must be paid the prevailing rate. Individual sole proprietors do not have to pay themselves prevailing rate but must report their hours on the project.
2. Work Class: List classification of work actually performed by employee. If unsure of work classification, consult the Ohio Bureau of Employment Services, Wage and Hour Division. Employees working more than one classification should have separate line entries for each classification. Indicate what year/level for Apprentices. Be specific when using laborer and operator classifications, for example, Backhoe Operator or Asphalt Laborer.
3. Hours Worked, Day & Date: In the first row of column 3 enter days of pay period example, M T W T H F S S U. The second row is for the date that corresponds with each day for the pay period. In the employee information section enter the number of hours worked on the prevailing wage project and which day the hours were worked. Separate rows are labeled for (ST) straight time hours and (OT) overtime hours. All hours worked after 40, must be paid at the appropriate overtime rate.
4. Project Total Hours: Total the hours entered for pay period.
5. Base Rate: Enter actual rate per hour paid to the employee. The overtime hourly rate is time and one-half the base rate listed in the prevailing wage schedule plus fringe benefits at straight time rate. The prevailing wage schedule lists the base rate plus fringe benefit amounts. These amounts added together equal the total prevailing wage rate. Employers must pay this total amount in one of three ways.
 - a) Total rate may be paid in entirety in the base rate to the employee; in which case, the cash designation will be checked for fringe benefits.
 - b) Total rate may be paid as listed in prevailing wage rate schedule with total fringe amounts paid approved plans.
 - c) Total rate may be paid with a combination of base rate and fringe payments to approved plans in amounts other than those listed in schedule.
6. Project Gross: Enter total gross wages earned on the project for straight time and overtime. Project hours X base rate should equal project gross.
7. Fringes: If fringe benefits are paid in the hourly base rate, indicate this by marking the cash space. If fringe benefits are paid to approved plans as listed in the prevailing wage rate schedule, mark the space Approved Plans. If fringe benefits are paid partially in the base rate and partially to approved plans, mark the space Cash & Approved plans. List the hourly amount paid to approved plans for each fringe. If payments are not made on a per hour basis, calculate the hourly fringe credit by dividing the yearly employer contribution by the lesser of: hours actually worked in the year (these must be documented) or 2080. Fringe benefits include: Employer's share of health insurance, life insurance, retirement plan, bonus/profit sharing, sick pay, holiday pay, personal leave, vacation, and education/training programs.
8. Total Hours All Jobs: Total all hours worked during the pay period including non-prevailing wage jobs.
9. Total Gross All Jobs: Gross amount earned in the pay period for all hours worked.
10. Self explanatory
11. Self explanatory
12. Self explanatory

CERTIFIED PAYROLL REPORT

Employer Name and Address				Name of General/Prime Contractor				Project Name and Location						Contracting Public Authority				
Check if Subcontractor ___		Week Ending:				Payroll #:		Page ___ of ___				Project Number:						
1. Employee Name, Address SSN		2. Work Class	3. Hours Worked Day & Date				4. Project Total Hrs	5. Base Rate	6. Project Gross	7. Fringes: Cash ___ Appd Plans ___ Cash & Approved Plans ___				8. Total Hrs All Jobs	9. Total Gross All Jobs	10. Taxes Withheld	11. Other Deducts	12. Net Paid
										H & W	Pens	Vac	Apo	Other				
		OT																
		ST																
		OT																
		ST																
		OT																
		ST																
		OT																
		ST																
		OT																
		ST																
		OT																
		ST																

Date _____ My signature on this form signifies that I pay, or supervise the payment of the employees shown above. I am certifying: 1) That during the pay period reported on this form, all hours worked on this project have been paid at the appropriate prevailing wage rate for the class of work done. 2) That fringe benefits have been paid as indicated above. 3) That no rebates or deductions have been or will be made, directly or indirectly from the total wages earned, other than permissible deductions as defined in the Ohio Revised Code Chapter 4115. 4) That apprentices are registered with the U.S. Department of Labor Bureau of Apprenticeship and Training. The willful falsification of any of the above statements may subject the contractor or subcontractor to civil or criminal prosecution.

NAME AND TITLE _____ SIGNATURE _____

PLEASE BE ADVISED THAT THIS FORM IS INTENDED TO BE USED AS A SAMPLE ONLY. IT IS NOT INTENDED TO BE THE ACTUAL PAYROLL REPORT TO BE FILED. IN ORDER TO COMPLY WITH THE STATE STATUTE REGARDING THE FILING OF CERTIFIED PAYROLL REPORTS, THE REPORT FILED BY YOUR COMPANY MUST INCLUDE A STATEMENT CERTIFYING THAT THE "PAYROLL IS CORRECT AND COMPLETE AND THE WAGES PAID ARE NOT LESS THAN THOSE REQUIRED BY THE CONTRACT". IF YOU HAVE ANY QUESTIONS REGARDING THE FILING OF CERTIFIED PAYROLL REPORTS, PLEASE CONTACT THE OHIO BUREAU OF EMPLOYMENT SERVICES, WAGE AND HOUR DIVISION AT (614)-644-2239.

CERTIFICATION

Date

I, _____
(Name of signatory part) (Title)

do hereby certify:

(1) That I pay or supervise the payment of the persons employed by

_____ on the _____
(Contractor or subcontractor) (Building or work)

_____ ; that during payroll period

commencing on the _____ day of _____ 20__ and

ending the _____ day of _____ 20__ all laborers

and mechanics employed on said project have been paid at the prevailing rate of wages for laborers and mechanics for the class of work called for by said project, and that no rebates have been or will be made either directly or indirectly to or on behalf of said

(Contractor or subcontractor)

from the total wages earned by any person and that no deduction have been made either directly or indirectly from the total wages earned by any person, other than permissible deductions as defined in Chapter 4115. Ohio Revised Code, and described below:

(2) That this and all payrolls required to be submitted for the above period are correct and complete; that the prevailing wage rates for laborers and mechanics are not less than the prevailing wage rates then payable in the same trade or occupation in the locality where the work is being performed, as determined by the Ohio Department of Industrial Relations; and, that the classifications set forth for each laborer and mechanic conform with the work performed,

(3) That apprentices employed during the above period are duly registered in a bona fide apprenticeship program registered with the State Apprenticeship Council.

(4) That:

(a) WHERE FRINGE BENEFITS ARE PAID TO APPROVED PLANS, FUNDS, OR PROGRAMS

- In addition to the base hourly wage rates paid to each laborer or mechanic listed in the above referenced payroll, payments of fringe benefits as determined by the Ohio Department of Industrial Relations have been made to

_____ in the amount of: \$ _____ for the benefit of such employees, except as noted in Section 4(c) below.

(b) WHERE FRINGE BENEFITS ARE PAID IN CASH

- Each laborer or mechanic listed in the above referenced payroll has been paid as indicated on the payroll, an amount not less than the sum of the applicable basic hourly wage ratio plus the amount of the required fringe benefits as determined by the Ohio Department of Industrial Relations, except as noted in Section 4(c) below.

(c) EXCEPTIONS

EXCEPTION (CRAFT)	EXPLANATION

Ohio Bureau of Employment Services
 Wage and Hour Division
 Remarks: 145 South Front Street
 PO Box 1618
 Columbus, Ohio 43216-1618

Name and Title	Signature
----------------	-----------

6.2.1

(SAMPLE)

AFFIDAVIT OF CONTRACTOR OR SUBCONTRACTOR

PREVAILING WAGES

Name of Company _____

I, _____, (Name of person signing affidavit) Title _____

do hereby certify that the wages paid to all employees for the full number of hours worked in connection with the Contract to the Improvement, Repair and Construction of:

(Project Name & Location)

during the following period from _____ to _____

is in accordance with the prevailing wage prescribed by the contractor document.

I further certify that no rebates or deductions for any wages due any person have been directly or indirectly made other than those provided by law.

(Signature of Officer or Agent)

Sworn to and subscribed in my presence this _____ day of _____, 20__.

(Notary Public)

The above affidavit must be executed and sworn to by the officer or agent or the Contractor or Subcontractor who supervises the payment of employees, before the owner will release the surety and/or make a final payment due under the terms of the Contract.

WAGE RATES

CURRENT PREVAILING
SUMMIT COUNTY

Prevailing Wage Rate Skilled Crafts

Name of Union: Asbestos Local 207 OH

Change # : LCN01-2018fbLoc207OH

Craft : Asbestos Worker Effective Date : 08/23/2018 Last Posted : 08/23/2018

	BHR	Fringe Benefit Payments						Irrevocable Fund		Total PWR	Overtime Rate
		H&W	Pension	App Tr.	Vac.	Annuity	Other	LECET (*)	MISC (*)		
Classification											
Asbestos Abatement	\$25.50	\$7.25	\$6.45	\$0.65	\$0.00	\$0.00	\$0.07	\$0.00	\$0.00	\$39.92	\$52.67
Trainee	\$16.50	\$7.25	\$1.50	\$0.65	\$0.00	\$0.00	\$0.07	\$0.00	\$0.00	\$25.97	\$34.22

Special Calculation Note :

Ratio :

3 Journeymen to 1 Trainee

Jurisdiction (* denotes special jurisdictional note) :

ADAMS, ASHLAND, ASHTABULA*, ATHENS, AUGLAIZE, BROWN, BUTLER*, CARROLL, CHAMPAIGN, CLARK, CLERMONT, CLINTON, COLUMBIANA, COSHOCTON, CRAWFORD, CUYAHOGA, DARKE, DELAWARE, FAIRFIELD, FAYETTE, FRANKLIN, GEAUGA, GREENE, GUERNSEY, HAMILTON, HARDIN, HARRISON, HIGHLAND, HOCKING, HOLMES, HURON, KNOX, LAKE, LICKING, LOGAN, LORAIN, MADISON, MAHONING, MARION, MEDINA, MIAMI, MONTGOMERY, MORGAN, MORROW, MUSKINGUM, NOBLE, PERRY, PICKAWAY, PORTAGE, PREBLE, RICHLAND, ROSS, SHELBY, STARK, SUMMIT, TRUMBULL, TUSCARAWAS, UNION, VINTON, WARREN*, WAYNE

Special Jurisdictional Note : Butler County:(townships of Fairfield,Hanover,Liberty,Milford,Morgan,Oxford,Ripley,Ross,StClair,Union & Wayne.) (Lemon & Madison) Warren County: (townships of: Deerfield, Hamilton, Harlan, Salem, Union & Washington). (Clear Creek, Franklin, Mossie, Turtle Creek & Wayney). Ashtabula County: (post offices & townships of Ashtabula, Austinburg, Geneva, Harperfield, Jefferson, Plymouth & Saybrook) (townships of Andover, Cherry Valley, Colbrook, Canneaut, Denmark, Dorset, East Orwell, Hartsgrove, Kingville, Lenox, Monroe,Morgan,New Lyme,North Kingsville, Orwell, Pierpoint, Richmond Rock Creek, Rome, Sheffield, Trumbull, Wayne, Williamsfield & Windsor) Erie County:(post offices & townships of Berlin, Berlin Heights,Birmingham,Florence ,Huron, Milan, Shinrock & Vermilion)

Details :

Asbestos & lead paint abatement including, but not limited to the removal or encapsulation of asbestos & lead paint, all work in conjunction with the preparation of the removal of same & all work in conjunction with the clean up after said removal. The removal of all insulation materials, whether they contain asbestos or not, from mechanical systems (pipes, boilers, ducts, flues, breaching, etc.) is recognized as being the exclusive work of the Asbestos Abatement Workers.

On all mechanical systems (pipes, boilers, ducts, flues, breaching, etc.) that are going to be demolished, the removal of all insulating materials whether they contain asbestos or not shall be the exclusive work of the Laborers. An Abatement Journeyman is anyone who has more than 300 hours in the Asbestos Abatement field.

Prevailing Wage Rate Skilled Crafts

Name of Union: Asbestos Local 84 Heat & Frost Insulators

Change # : LCN01-2018fbLoc84

Craft : Asbestos Worker Effective Date : 06/06/2018 Last Posted : 06/06/2018

	BHR		Fringe Benefit Payments					Irrevocable Fund		Total PWR	Overtime Rate	
			H&W	Pension	App Tr.	Vac.	Annuity	Other	LECET (*)			MISC (*)
Classification												
Asbestos Insulation Worker	\$31.47		\$9.49	\$8.36	\$0.36	\$0.00	\$3.39	\$0.24	\$0.00	\$0.00	\$53.31	\$69.04
Apprentice	Percent											
1st Year	50.00	\$15.74	\$9.49	\$8.36	\$0.36	\$0.00	\$3.39	\$0.24	\$0.00	\$0.00	\$37.58	\$45.44
2nd Year	60.00	\$18.88	\$9.49	\$8.36	\$0.36	\$0.00	\$3.39	\$0.24	\$0.00	\$0.00	\$40.72	\$50.16
3rd Year	70.00	\$22.03	\$9.49	\$8.36	\$0.36	\$0.00	\$3.39	\$0.24	\$0.00	\$0.00	\$43.87	\$54.88
4th Year	80.00	\$25.18	\$9.49	\$8.36	\$0.36	\$0.00	\$3.39	\$0.24	\$0.00	\$0.00	\$47.02	\$59.60

Special Calculation Note : Other is Industry and Labor Management Fund

Ratio :

3 Journeymen to 1 Apprentice per shop

Jurisdiction (* denotes special jurisdictional note) :

ASHLAND, ASHTABULA*, CARROLL, COLUMBIANA, COSHOCTON, ERIE*, HARRISON, HOLMES, MAHONING, MEDINA, PORTAGE, RICHLAND, STARK, SUMMIT, TRUMBULL, TUSCARAWAS, WAYNE

Special Jurisdictional Note : Ashtabula County: except for the townships of Ashtabula, Austinburg, Geneva, Harpersfield, Jefferson, Plymouth and Saybrook. Erie except Sandusky city limits.

Details :

The removal of all insulation materials, whether they contain asbestos or not, from mechanical systems (pipes, boilers, ducts, flues, breaching, etc.) is recognized as being the exclusive work of the Asbestos Workers. On all mechanical systems (pipes, boilers, ducts, flues, breaching, etc.) that are going to be demolished, the removal of all insulating materials whether they contain asbestos or not shall be the exclusive work of the Laborers.

Prevailing Wage Rate Skilled Crafts

Name of Union: Boilermaker Local 744

Change # : LCNO1-2019fbLoc744

Craft : Boilermaker Effective Date : 04/03/2019 Last Posted : 04/03/2019

	BHR		Fringe Benefit Payments					Irrevocable Fund		Total PWR	Overtime Rate	
			H&W	Pension	App Tr.	Vac.	Annuity	Other	LECET (*)			MISC (*)
Classification												
Boilermaker	\$38.05		\$7.07	\$16.07	\$0.74	\$0.00	\$5.08	\$0.75	\$0.00	\$0.00	\$67.76	\$86.78
Apprentice	Percent											
1st 6 months	70.02	\$26.64	\$7.07	\$16.07	\$0.74	\$0.00	\$5.08	\$0.75	\$0.00	\$0.00	\$56.35	\$69.67
2nd 6 months	72.52	\$27.59	\$7.07	\$16.07	\$0.74	\$0.00	\$5.08	\$0.75	\$0.00	\$0.00	\$57.30	\$71.10
3rd 6 months	75.00	\$28.54	\$7.07	\$16.07	\$0.74	\$0.00	\$5.08	\$0.75	\$0.00	\$0.00	\$58.25	\$72.52
4th 6 months	77.51	\$29.49	\$7.07	\$16.07	\$0.74	\$0.00	\$5.08	\$0.75	\$0.00	\$0.00	\$59.20	\$73.95
5th 6 months	80.00	\$30.44	\$7.07	\$16.07	\$0.74	\$0.00	\$5.08	\$0.75	\$0.00	\$0.00	\$60.15	\$75.37
6th 6 months	85.03	\$32.35	\$7.07	\$16.07	\$0.74	\$0.00	\$5.08	\$0.75	\$0.00	\$0.00	\$62.06	\$78.24
7th 6 months	90.00	\$34.25	\$7.07	\$16.07	\$0.74	\$0.00	\$5.08	\$0.75	\$0.00	\$0.00	\$63.96	\$81.08
8th 6 months	95.00	\$36.15	\$7.07	\$16.07	\$0.74	\$0.00	\$5.08	\$0.75	\$0.00	\$0.00	\$65.86	\$83.93
Helper	60.00	\$22.83	\$7.07	\$16.07	\$0.74	\$0.00	\$5.08	\$0.75	\$0.00	\$0.00	\$52.54	\$63.96

Special Calculation Note : Other is Supplemental Health

Ratio :

5 Journeymen to 1 Apprentice to 1 Helper

Jurisdiction (* denotes special jurisdictional note) :

ASHTABULA, CARROLL, COSHOCTON, CUYAHOGA, GEAUGA, HARRISON, HOLMES, LAKE, LORAIN, MAHONING, MEDINA, PORTAGE, STARK, SUMMIT, TRUMBULL, TUSCARAWAS, WAYNE

Special Jurisdictional Note :

Details :

Prevailing Wage Rate Skilled Crafts

Name of Union: Bricklayer Local 36 Zone 2 Tile Layer

Change # : LCN01-2020fbLoc7

Craft : Bricklayer Effective Date : 05/01/2020 Last Posted : 04/30/2020

	BHR		Fringe Benefit Payments					Irrevocable Fund		Total PWR	Overtime Rate	
			H&W	Pension	App Tr.	Vac.	Annuity	Other	LECET (*)			MISC (*)
Classification												
Bricklayer Tile Layer	\$29.83		\$8.40	\$3.62	\$0.64	\$0.00	\$1.20	\$0.00	\$0.00	\$0.00	\$43.69	\$58.60
Tile Layer Apprentice	Percent											
1st 30 days	60.00	\$17.90	\$0.00	\$0.00	\$0.00	\$0.00	\$0.00	\$0.00	\$0.00	\$0.00	\$17.90	\$26.85
1st 6 months	60.00	\$17.90	\$8.40	\$0.00	\$0.00	\$0.00	\$0.00	\$0.00	\$0.00	\$0.00	\$26.30	\$35.25
2nd 6 months	65.00	\$19.39	\$8.40	\$3.62	\$0.64	\$0.00	\$1.20	\$0.00	\$0.00	\$0.00	\$33.25	\$42.94
3rd 6 months	70.00	\$20.88	\$8.40	\$3.62	\$0.64	\$0.00	\$1.20	\$0.00	\$0.00	\$0.00	\$34.74	\$45.18
4th 6 months	75.00	\$22.37	\$8.40	\$3.62	\$0.64	\$0.00	\$1.20	\$0.00	\$0.00	\$0.00	\$36.23	\$47.42
5th 6 months	80.00	\$23.86	\$8.40	\$3.62	\$0.64	\$0.00	\$1.20	\$0.00	\$0.00	\$0.00	\$37.72	\$49.66
6th 6 months	85.00	\$25.36	\$8.40	\$3.62	\$0.64	\$0.00	\$1.20	\$0.00	\$0.00	\$0.00	\$39.22	\$51.89
7th 6 months	90.00	\$26.85	\$8.40	\$3.62	\$0.64	\$0.00	\$1.20	\$0.00	\$0.00	\$0.00	\$40.71	\$54.13
8th 6 months	95.00	\$28.34	\$8.40	\$3.62	\$0.64	\$0.00	\$1.20	\$0.00	\$0.00	\$0.00	\$42.20	\$56.37

Special Calculation Note : Classification title contains "Bricklayer" because contract originates within the Bricklayer Local.

Note that the classification description is clarified after the local union number at the top of the page.

Ratio :

- 1-4 Journeyman to 1 Apprentice
- 5-10 Journeymen to 2 Apprentice
- 11-16 Journeymen to 3 Apprentices

Jurisdiction (* denotes special jurisdictional note) :

PORTAGE, SUMMIT

Special Jurisdictional Note :

Details :

Prevailing Wage Rate Skilled Crafts

Name of Union: Bricklayer Local 36 Zone 2 Tile Finisher

Change # : LCN01-2020fbLoc7

Craft : Bricklayer Effective Date : 12/24/2020 Last Posted : 12/24/2020

	BHR		Fringe Benefit Payments						Irrevocable Fund		Total PWR	Overtime Rate
			H&W	Pension	App Tr.	Vac.	Annuity	Other	LECET (*)	MISC (*)		
Classification												
Bricklayer Tile Finisher	\$24.48		\$8.40	\$3.62	\$0.58	\$0.00	\$1.23	\$0.00	\$0.00	\$0.00	\$38.31	\$50.55
Apprentice												
	Percent											
1st 6 months	60.00	\$14.69	\$8.40	\$0.00	\$0.00	\$0.00	\$0.00	\$0.00	\$0.00	\$0.00	\$23.09	\$30.43
2nd 6 months	70.00	\$17.14	\$8.40	\$3.62	\$0.58	\$0.00	\$1.23	\$0.00	\$0.00	\$0.00	\$30.97	\$39.53
3rd 6 months	75.00	\$18.36	\$8.40	\$3.62	\$0.58	\$0.00	\$1.23	\$0.00	\$0.00	\$0.00	\$32.19	\$41.37
4th 6 months	80.00	\$19.58	\$8.40	\$3.62	\$0.58	\$0.00	\$1.23	\$0.00	\$0.00	\$0.00	\$33.41	\$43.21
5th 6 months	85.00	\$20.81	\$8.40	\$3.62	\$0.58	\$0.00	\$1.23	\$0.00	\$0.00	\$0.00	\$34.64	\$45.04
6th 6 months	90.00	\$22.03	\$8.40	\$3.62	\$0.58	\$0.00	\$1.23	\$0.00	\$0.00	\$0.00	\$35.86	\$46.88

Special Calculation Note : Classification title contains "Bricklayer" because contract originates within the Bricklayer Local.

Note that the classification description is clarified after the local union number at the top of the page.

Ratio :

- 1-4 Journeymen to 1 Apprentice
- 5-10 Journeymen to 2 Apprentices
- 11-16 Journeymen to 3 Apprentices

Jurisdiction (* denotes special jurisdictional note) :

PORTAGE, SUMMIT

Special Jurisdictional Note :

Details :

The rate of Sewer Bricklayer will be \$.50 cents per above the building bricklayer's rate. Men working from cable or rope hung scaffold shall receive .50 cents per hour above building bricklayer rate.

Prevailing Wage Rate Skilled Crafts

Name of Union: Bricklayer Local 5 Marble Mason

Change # : LCN01-2020fbLoc5

Contract : Bricklayer Effective Date : 06/18/2020 Last Posted : 06/18/2020

Classification	BHR		Fringe Benefit Payments					Irrevocable Fund		Total PWR	Overtime Rate	
			H&W	Pension	App Tr.	Vac.	Annuity	Other	LECET (*)			MISC (*)
Bricklayer Horizontal Marble Mason	\$25.08		\$8.09	\$9.00	\$0.63	\$0.00	\$0.00	\$0.00	\$0.00	\$0.00	\$42.80	\$55.34
Masonry Maintenance Specialist	\$12.54		\$0.00	\$0.00	\$0.00	\$0.00	\$0.00	\$0.00	\$0.00	\$0.00	\$12.54	\$18.81
Apprentice	Percent											
1st 6 Months	60.00	\$15.05	\$8.09	\$0.00	\$0.00	\$0.00	\$0.00	\$0.00	\$0.00	\$0.00	\$23.14	\$30.66
2nd 6 Months	65.00	\$16.30	\$8.09	\$1.60	\$0.63	\$0.00	\$0.00	\$0.00	\$0.00	\$0.00	\$26.62	\$34.77
3rd 6 Months	70.00	\$17.56	\$8.09	\$9.00	\$0.63	\$0.00	\$0.00	\$0.00	\$0.00	\$0.00	\$35.28	\$44.05
4th 6 Months	75.00	\$18.81	\$8.09	\$9.00	\$0.63	\$0.00	\$0.00	\$0.00	\$0.00	\$0.00	\$36.53	\$45.93
5th 6 Months	80.00	\$20.06	\$8.09	\$9.00	\$0.63	\$0.00	\$0.00	\$0.00	\$0.00	\$0.00	\$37.78	\$47.82
6th 6 Months	85.00	\$21.32	\$8.09	\$9.00	\$0.63	\$0.00	\$0.00	\$0.00	\$0.00	\$0.00	\$39.04	\$49.70
MASON TRAINEES												
1st 90 Days	45.00	\$11.29	\$0.00	\$0.00	\$0.00	\$0.00	\$0.00	\$0.00	\$0.00	\$0.00	\$11.29	\$16.93
1st year after 90 Days	45.00	\$11.29	\$8.09	\$0.00	\$0.00	\$0.00	\$0.00	\$0.00	\$0.00	\$0.00	\$19.38	\$25.02
2nd Year	50.00	\$12.54	\$8.09	\$0.00	\$0.00	\$0.00	\$0.00	\$0.00	\$0.00	\$0.00	\$20.63	\$26.90

Special Calculation Note : No special calculations for this skilled craft wage rate are required at this time.

Classification title contains "Bricklayer" because contract originates within the Bricklayer Local.

- Ratio :**
- 2 Journeyman to 1 Apprentice
 - 4 Journeyman to 2 Apprentices
 - 6 Journeyman to 2 Apprentices
 - 10 Journeyman to 3 Apprentices

Jurisdiction (* denotes special jurisdictional note) :
ASHTABULA, CUYAHOGA, GEAUGA, LAKE, LORAIN, MEDINA,
PORTAGE, SUMMIT

- Apprentice permits 1 Mason Trainee
- Apprentice permits 1 Mason Trainee
- Apprentice permits 2 Mason Trainee
- Apprentice permits 2 Mason Trainee

Special Jurisdictional Note :

Details :
In the mutual interest of both Employer and Union and to promote the masonry industry, it is agreed that the Employer may work with the Union and the Local Educational Partners in the jurisdiction of this agreement to employ School to work students provided that no conflicts exist with any Federal or State laws. Employer must be party to a bonified Apprenticeship and Training program registered with the State of Ohio (OSAC). It is further agreed by both parties that the wages for the Masonry Maintenance Specialist shall be forty-five percent (45%) of the journeyman rate with no fringe benefits or as specified by the Local Educational Partner in the jurisdiction of the agreement.

Prevailing Wage Rate Skilled Crafts

Name of Union: Bricklayer Local 5 Marble, Terrazzo & Mosaic

Change #: LCN01-2020fbLoc5

Contract: Bricklayer Effective Date : 06/18/2020 Last Posted : 06/18/2020

Classification	BHR		Fringe Benefit Payments					Irrevocable Fund		Total PWR	Overtime Rate	
			H&W	Pension	App Tr.	Vac.	Annuity	Other	LECET (*)			MISC (*)
Bricklayer Marble, Terrazzo, Mosaic	\$35.88		\$8.09	\$9.00	\$0.74	\$0.00	\$0.00	\$0.00	\$0.00	\$0.00	\$53.71	\$71.65
Bricklayer Scaffold Workers	\$35.88		\$8.09	\$9.00	\$0.74	\$0.00	\$0.00	\$0.00	\$0.00	\$0.00	\$53.71	\$71.65
Bricklayer	\$36.38		\$8.09	\$9.00	\$0.74	\$0.00	\$0.00	\$0.00	\$0.00	\$0.00	\$54.21	\$72.40
Masonry Maintenance	\$16.15		\$0.00	\$0.00	\$0.00	\$0.00	\$0.00	\$0.00	\$0.00	\$0.00	\$16.15	\$24.22
Apprentice	Percent											
1st 6 months	60.00	\$21.53	\$8.09	\$0.00	\$0.00	\$0.00	\$0.00	\$0.00	\$0.00	\$0.00	\$29.62	\$40.38
2nd 6 months	65.00	\$23.32	\$8.09	\$9.00	\$0.74	\$0.00	\$0.00	\$0.00	\$0.00	\$0.00	\$41.15	\$52.81
3rd 6 months	70.00	\$25.12	\$8.09	\$9.00	\$0.74	\$0.00	\$0.00	\$0.00	\$0.00	\$0.00	\$42.95	\$55.50
4th 6 months	75.00	\$26.91	\$8.09	\$9.00	\$0.74	\$0.00	\$0.00	\$0.00	\$0.00	\$0.00	\$44.74	\$58.20
5th 6 months	80.00	\$28.70	\$8.09	\$9.00	\$0.74	\$0.00	\$0.00	\$0.00	\$0.00	\$0.00	\$46.53	\$60.89
6th 6 months	85.00	\$30.50	\$8.09	\$9.00	\$0.74	\$0.00	\$0.00	\$0.00	\$0.00	\$0.00	\$48.33	\$63.58
7th 6 months	90.00	\$32.29	\$8.09	\$9.00	\$0.74	\$0.00	\$0.00	\$0.00	\$0.00	\$0.00	\$50.12	\$66.27
8th 6 months	95.00	\$34.09	\$8.09	\$9.00	\$0.74	\$0.00	\$0.00	\$0.00	\$0.00	\$0.00	\$51.92	\$68.96
MASON TRAINEE 1st 90 Days	45.00	\$16.15	\$0.00	\$0.00	\$0.00	\$0.00	\$0.00	\$0.00	\$0.00	\$0.00	\$16.15	\$24.22
1st Year after 90 Days	45.00	\$16.15	\$8.09	\$0.00	\$0.00	\$0.00	\$0.00	\$0.00	\$0.00	\$0.00	\$24.24	\$32.31
2nd Year	50.00	\$17.94	\$8.09	\$0.00	\$0.00	\$0.00	\$0.00	\$0.00	\$0.00	\$0.00	\$26.03	\$35.00

Special Calculation Note : Classification title contains "Bricklayer" because contract originates within the Bricklayer Local.

Ratio :
 2 Journeyman to 1 Apprentice
 4 Journeyman to 2 Apprentices
 6 Journeyman to 3 Apprentices
 10 Journeyman to 4 Apprentices

Jurisdiction (* denotes special jurisdictional note) :
 ASHTABULA, GEAUGA, LAKE, PORTAGE, SUMMIT

Apprentice permits 1 Mason Trainee
 Apprentice permits 1 Mason Trainee
 Apprentice permits 2 Mason Trainee
 Apprentice permits 2 Mason Trainee

Special Jurisdictional Note :

Details :
 In the mutual interest of both Employer and Union and to promote the masonry industry, it is agreed that the Employer may work with the Union and the Local Educational Partners in the jurisdiction of this agreement to employ School to work students provided that no conflicts exist with any Federal or State Laws. Employee must be party to a bonified Apprenticeship and Training program registered with the State of Ohio (OSAC). It is further agreed by both parties that the wages for the Masonry Maintenance Specialist shall be forty-five percent (45%) of the journeyman rate with no fringe benefits or as specified by the Local Educational Partner in the jurisdiction of the agreement.

Prevailing Wage Rate Skilled Crafts

Name of Union: Bricklayer Local 5 Tile & Marble Finisher

Change # : LCN01-2020fbLoc5

Contract : Bricklayer Effective Date : 06/18/2020 Last Posted : 06/18/2020

	BHR		Fringe Benefit Payments					Irrevocable Fund		Total PWR	Overtime Rate	
			H&W	Pension	App Tr.	Vac.	Annuity	Other	LECET (*)			MISC (*)
Classification												
Bricklayer Tile Marble Finisher	\$29.20		\$8.09	\$4.53	\$0.63	\$0.00	\$0.00	\$0.00	\$0.00	\$0.00	\$42.45	\$57.05
Apprentice Tile Marble Finishers	Percent											
1st 6 months	60.00	\$17.52	\$8.09	\$0.00	\$0.00	\$0.00	\$0.00	\$0.00	\$0.00	\$0.00	\$25.61	\$34.37
2nd 6 months	70.00	\$20.44	\$8.09	\$4.53	\$0.63	\$0.00	\$0.00	\$0.00	\$0.00	\$0.00	\$33.69	\$43.91
3rd 6 months	75.00	\$21.90	\$8.09	\$4.53	\$0.63	\$0.00	\$0.00	\$0.00	\$0.00	\$0.00	\$35.15	\$46.10
4th 6 months	80.00	\$23.36	\$8.09	\$4.53	\$0.63	\$0.00	\$0.00	\$0.00	\$0.00	\$0.00	\$36.61	\$48.29
5th 6 months	85.00	\$24.82	\$8.09	\$4.53	\$0.63	\$0.00	\$0.00	\$0.00	\$0.00	\$0.00	\$38.07	\$50.48
6th 6 months	90.00	\$26.28	\$8.09	\$4.53	\$0.63	\$0.00	\$0.00	\$0.00	\$0.00	\$0.00	\$39.53	\$52.67

Special Calculation Note : Classification title contains "Bricklayer" because contract originates within the Bricklayer Local. Note that the classification description is clarified after the local union number at the top of the page.

Ratio :
 -2 Journeymen to 1 Apprentice
 - 4 Journeymen to 2 Apprentice
 -6 Journeymen to 3 Apprentice
 -8 Journeymen to 4 Apprentice

Jurisdiction (* denotes special jurisdictional note) :
 ASHTABULA, CUYAHOGA, GEAUGA, LAKE, LORAIN, MEDINA, PORTAGE, SUMMIT

Special Jurisdictional Note :

Tile Finishers: do all the cleaning, acid washing, grouting, by any methods or means. Also unpacking of all tiles, opening of all mastic containers, mixing of all mortar, thin-set and epoxy materials, also the distribution of it. They shall handle and distribute all materials such as sand, cement, lime, tile, all types of tile panels, prefabricated tile units, plastic materials and protective covering of all tile. Clean up and removal of all materials used in connection of said work.

Terrazzo Finishers: Assisting in grinding, and handling of material whether by hand or wheel barrow, or power buggies, including sand Portland cement, resinous cement and admixtures, aggregates of marble, stone or other compositions, bonding adhesives, sealers, waxes, and coatings used for Terrazzo Mosaic work, preparing, mixing by hand or machine, and distributing (spreading) all kinds of underbed or underlayment necessary and all scratch coat used for terrazzo and mosaic work. Also the rubbing, grinding, cleaning, sealing and polishing same either by hand or machine. They shall assist in the installation of the sand bed, tar paper, wire lath, divider strips, and rolling procedures and acid etching of all concrete floors that require it before installation. Shall handle all materials and assist in the installation of all types of terrazzo floors whether conventional or thin-set variety.

Marble Finishers: Loading and unloading handling and distributing of marble materials including the mixing of all materials used for the installation of marble, such as cement underbeds for the floors, thin-set or epoxies including but not limited to plastic materials. Clean up and removal of all waster material of said work. Cleaning and grouting of all marble and slate, and all polishing of marble and slate floors.

Prevailing Wage Rate Skilled Crafts

Name of Union: Bricklayer Local 5 Terrazzo Finisher

Change # : LCN01-2020fbLoc5

Craft : Bricklayer Effective Date : 06/18/2020 Last Posted : 06/18/2020

	BHR		Fringe Benefit Payments					Irrevocable Fund		Total PWR	Overtime Rate	
			H&W	Pension	App Tr.	Vac.	Annuity	Other	LECET (*)			MISC (*)
Classification												
Bricklayer Terrazzo Finisher	\$28.82		\$8.09	\$4.91	\$0.63	\$0.00	\$0.00	\$0.00	\$0.00	\$0.00	\$42.45	\$56.86
Apprentice Terrazzo Finishers	Percent											
1st 6 months	60.00	\$17.29	\$8.09	\$0.00	\$0.00	\$0.00	\$0.00	\$0.00	\$0.00	\$0.00	\$25.38	\$34.03
2nd 6 months	70.00	\$20.17	\$8.09	\$4.91	\$0.63	\$0.00	\$0.00	\$0.00	\$0.00	\$0.00	\$33.80	\$43.89
3rd 6 months	75.00	\$21.62	\$8.09	\$4.91	\$0.63	\$0.00	\$0.00	\$0.00	\$0.00	\$0.00	\$35.25	\$46.05
4th 6 months	80.00	\$23.06	\$8.09	\$4.91	\$0.63	\$0.00	\$0.00	\$0.00	\$0.00	\$0.00	\$36.69	\$48.21
5th 6 months	85.00	\$24.50	\$8.09	\$4.91	\$0.63	\$0.00	\$0.00	\$0.00	\$0.00	\$0.00	\$38.13	\$50.38
6th 6 months	90.00	\$25.94	\$8.09	\$4.91	\$0.63	\$0.00	\$0.00	\$0.00	\$0.00	\$0.00	\$39.57	\$52.54

Special Calculation Note : Classification title contains "Bricklayer" because contract originates within the Bricklayer Local. Note that the classification description is clarified after the local union number at the top of the page.

Ratio :

- 2 Journeymen to 1 Apprentice
- 4 Journeymen to 2 Apprentices
- 6 Journeymen to 3 Apprentices
- 8 Journeymen to 4 Apprentices

Jurisdiction (* denotes special jurisdictional note) :

ASHTABULA, CUYAHOGA, GEAUGA, LAKE, LORAIN, MEDINA, PORTAGE, SUMMIT

Special Jurisdictional Note :

Details :

Tile Finishers:do all the cleaning, acid washing,grouting,by any methods or means. Also unpacking of all tiles,opening of all mastic containers,mixing of all mortar,thin-set and epoxy materials,also the distribution of it. They shall handle and distribute all materials such as sand,cement,lime,tile,all types of tile panels,prefabricated tile units, plastic materials and protective covering of all tile.Clean up and removal of all materials always used in connection of said work.

Terrazzo Finishers:Assisting in grinding, and handling of material whether by hand or wheel barrow, or power buggies, including sand and portland cement, resinous cement and admixtures, aggregates of marble, stone or other compositions, bonding adhesives, sealers, waxes, and coatings used for Terrazzo Mosaic work, preparing, mixing by hand or machine, and distributing (spreading) all kinds of underbed or underlayment necessary and all scratch coat used for terrazzo and mosaic work. Also the rubbing, grinding, cleaning, sealing and polishing same either by hand or machine. will assist in the installation of the sand bed, tar paper, wire lath, divider strips, and rolling procedures and acid etching of all concrete floors that require it before installation. Shall handle all materials and assist in the installation of all types of terrazzo floors whether conventional or thin-set variety.

Marble Finishers:Loading and unloading handling and distributing of marble materials including the mixing of all materials used for the installation of marble, such as cement underbeds for the floors, thin-set or epoxies including but not limited to plastic materials. Clean up and removal of all waster material of said work. Cleaning and grouting of all marble and slate, and all polishing of marble and slate floors.

Prevailing Wage Rate Skilled Crafts

Name of Union: Bricklayer Local 7

Change # : LCR01-2020fbLoc7

Craft : Bricklayer Effective Date : 06/01/2020 Last Posted : 05/21/2020

	BHR		Fringe Benefit Payments					Irrevocable Fund		Total PWR	Overtime Rate	
			H&W	Pension	App Tr.	Vac.	Annuity	Other	LECET (*)			MISC (*)
Classification												
Bricklayer	\$31.97		\$8.60	\$8.16	\$0.72	\$0.00	\$2.50	\$0.00	\$0.00	\$0.00	\$51.95	\$67.93
Pointer Caulker Cleaner	\$31.97		\$8.60	\$8.16	\$0.72	\$0.00	\$2.50	\$0.00	\$0.00	\$0.00	\$51.95	\$67.93
Swing Scaffold Workers	\$32.47		\$8.60	\$8.16	\$0.72	\$0.00	\$2.50	\$0.00	\$0.00	\$0.00	\$52.45	\$68.68
Sewer Stack	\$32.47		\$8.60	\$8.16	\$0.72	\$0.00	\$2.50	\$0.00	\$0.00	\$0.00	\$52.45	\$68.68
Total Pay	\$32.97		\$8.60	\$8.16	\$0.72	\$0.00	\$2.50	\$0.00	\$0.00	\$0.00	\$52.95	\$69.43
Stone Mason	\$31.97		\$8.60	\$8.16	\$0.72	\$0.00	\$2.50	\$0.00	\$0.00	\$0.00	\$51.95	\$67.93
Apprentice	Percent											
1st 6 Months	60.00	\$19.18	\$8.60	\$0.00	\$0.00	\$0.00	\$0.00	\$0.00	\$0.00	\$0.00	\$27.78	\$37.37
2nd 6 Months	65.00	\$20.78	\$8.60	\$8.16	\$0.72	\$0.00	\$2.50	\$0.00	\$0.00	\$0.00	\$40.76	\$51.15
3rd 6 Months	70.00	\$22.38	\$8.60	\$8.16	\$0.72	\$0.00	\$2.50	\$0.00	\$0.00	\$0.00	\$42.36	\$53.55
4th 6 Months	75.00	\$23.98	\$8.60	\$8.16	\$0.72	\$0.00	\$2.50	\$0.00	\$0.00	\$0.00	\$43.96	\$55.95
5th 6 Months	80.00	\$25.58	\$8.60	\$8.16	\$0.72	\$0.00	\$2.50	\$0.00	\$0.00	\$0.00	\$45.56	\$58.34
6th 6 Months	85.00	\$27.17	\$8.60	\$8.16	\$0.72	\$0.00	\$2.50	\$0.00	\$0.00	\$0.00	\$47.15	\$60.74
7th 6 Months	90.00	\$28.77	\$8.60	\$8.16	\$0.72	\$0.00	\$2.50	\$0.00	\$0.00	\$0.00	\$48.75	\$63.14
8th 6 Months	95.00	\$30.37	\$8.60	\$8.16	\$0.72	\$0.00	\$2.50	\$0.00	\$0.00	\$0.00	\$50.35	\$65.54

Special Calculation Note : No special calculations for this skilled craft wage rate are required at this time.

Ratio :
 10 Journeymen to 1 Apprentice
 20 Journeymen to 2 Apprentice
 5 Journeymen to 3 Apprentice

Jurisdiction (* denotes special jurisdictional note) :
 PORTAGE, SUMMIT

Special Jurisdictional Note :

Details :

Prevailing Wage Rate Skilled Crafts

Name of Union: Bricklayer Local 7 Marble Mason

Change # : LCN01-2013fbLoc7

Craft : Bricklayer Effective Date : 06/26/2013 Last Posted : 06/26/2013

	BHR		Fringe Benefit Payments					Irrevocable Fund		Total PWR	Overtime Rate	
			H&W	Pension	App Tr.	Vac.	Annuity	Other	LECET (*)			MISC (*)
Classification												
Bricklayer Marble Mason	\$29.67		\$6.40	\$2.55	\$0.60	\$0.00	\$0.00	\$0.00	\$0.00	\$0.00	\$39.22	\$54.06
Terrazzo Worker	\$29.67		\$6.40	\$2.55	\$0.60	\$0.00	\$0.00	\$0.00	\$0.00	\$0.00	\$39.22	\$54.06
Apprentice	Percent											
1st 6 Months	60.00	\$17.80	\$6.40	\$0.00	\$0.00	\$0.00	\$0.00	\$0.00	\$0.00	\$0.00	\$24.20	\$33.10
2nd 6 Months	70.00	\$20.77	\$6.40	\$2.55	\$0.60	\$0.00	\$0.00	\$0.00	\$0.00	\$0.00	\$30.32	\$40.70
3rd 6 Months	75.00	\$22.25	\$6.40	\$2.55	\$0.60	\$0.00	\$0.00	\$0.00	\$0.00	\$0.00	\$31.80	\$42.93
4th 6 Months	80.00	\$23.74	\$6.40	\$2.55	\$0.60	\$0.00	\$0.00	\$0.00	\$0.00	\$0.00	\$33.29	\$45.15
5th 6 Months	85.00	\$25.22	\$6.40	\$2.55	\$0.60	\$0.00	\$0.00	\$0.00	\$0.00	\$0.00	\$34.77	\$47.38
6th 6 Months	90.00	\$26.70	\$6.40	\$2.55	\$0.60	\$0.00	\$0.00	\$0.00	\$0.00	\$0.00	\$36.25	\$49.60

Special Calculation Note : No special calculations for this skilled craft wage rate are required at this time.

Classification title contains "Bricklayer" because contract originates within the Bricklayer Local. Note that the classification description is clarified after the local union number at the top of the page.

Ratio : Jurisdiction (* denotes special jurisdictional note) :

1 Journeymen to 1 Apprentice
5 Journeymen to 1 Apprentice
10 Journeymen to 2 Apprentice
15 Journeymen to 3 Apprentice

PORTAGE, SUMMIT

Special Jurisdictional Note :

Details :

Prevailing Wage Rate Skilled Crafts

Name of Union: Carpenter Commercial NE Zone 1A

Change # : LCN01-2020fbLocNEZone1A

Craft : Carpenter Effective Date : 05/28/2020 Last Posted : 05/28/2020

	BHR		Fringe Benefit Payments					Irrevocable Fund		Total PWR	Overtime Rate	
			H&W	Pension	App Tr.	Vac.	Annuity	Other	LECET (*)			MISC (*)
Classification												
Carpenter	\$30.94		\$7.75	\$9.78	\$0.50	\$0.00	\$2.59	\$0.00	\$0.00	\$0.00	\$51.56	\$67.03
Apprentice	Percent											
1st 3 months	60.00	\$18.56	\$0.00	\$0.00	\$0.00	\$0.00	\$0.00	\$0.00	\$0.00	\$0.00	\$18.56	\$27.85
2nd 3 months	60.00	\$18.56	\$7.75	\$0.00	\$0.50	\$0.00	\$0.00	\$0.00	\$0.00	\$0.00	\$26.81	\$36.10
2nd 6 months is 1st year	60.00	\$18.56	\$7.75	\$0.00	\$0.50	\$0.00	\$0.00	\$0.00	\$0.00	\$0.00	\$26.81	\$36.10
3rd 6 months	60.00	\$18.56	\$7.75	\$0.00	\$0.50	\$0.00	\$0.00	\$0.00	\$0.00	\$0.00	\$26.81	\$36.10
4th 6 months	60.00	\$18.56	\$7.75	\$0.00	\$0.50	\$0.00	\$0.00	\$0.00	\$0.00	\$0.00	\$26.81	\$36.10
5th 6 months	70.00	\$21.66	\$7.75	\$6.85	\$0.50	\$0.00	\$1.81	\$0.00	\$0.00	\$0.00	\$38.57	\$49.40
6th 6 months	75.00	\$23.21	\$7.75	\$7.34	\$0.50	\$0.00	\$1.94	\$0.00	\$0.00	\$0.00	\$40.74	\$52.34
7th 6 months	80.00	\$24.75	\$7.75	\$7.82	\$0.50	\$0.00	\$2.07	\$0.00	\$0.00	\$0.00	\$42.89	\$55.27
8th 6 months	85.00	\$26.30	\$7.75	\$8.31	\$0.50	\$0.00	\$2.20	\$0.00	\$0.00	\$0.00	\$45.06	\$58.21

Special Calculation Note :

Ratio :

2 Journeymen to 1 Apprentice

Jurisdiction (* denotes special jurisdictional note) :

MEDINA, PORTAGE, SUMMIT

Special Jurisdictional Note :

Details :

Prevailing Wage Rate

Skilled Crafts

Name of Union: Carpenter Floorlayer NE Zone 1A

Change # : LCN01-2020fbLocNEZone1A

Craft : Carpenter Effective Date : 05/28/2020 Last Posted : 05/28/2020

	BHR		Fringe Benefit Payments					Irrevocable Fund		Total PWR	Overtime Rate	
			H&W	Pension	App Tr.	Vac.	Annuity	Other	LECET (*)			MISC (*)
Classification												
Carpenter Floorlayer	\$30.94		\$7.75	\$9.78	\$0.52	\$0.00	\$2.59	\$0.00	\$0.00	\$0.00	\$51.58	\$67.05
Apprentice	Percent											
1st 3 months	60.00	\$18.56	\$0.00	\$0.00	\$0.00	\$0.00	\$0.00	\$0.00	\$0.00	\$0.00	\$18.56	\$27.85
2nd 3 months	60.00	\$18.56	\$7.75	\$0.00	\$0.52	\$0.00	\$0.00	\$0.00	\$0.00	\$0.00	\$26.83	\$36.12
2nd 6 months	60.00	\$18.56	\$7.75	\$0.00	\$0.52	\$0.00	\$0.00	\$0.00	\$0.00	\$0.00	\$26.83	\$36.12
3rd 6 months	60.00	\$18.56	\$7.75	\$0.00	\$0.52	\$0.00	\$0.00	\$0.00	\$0.00	\$0.00	\$26.83	\$36.12
4th 6 months	60.00	\$18.56	\$7.75	\$0.00	\$0.52	\$0.00	\$0.00	\$0.00	\$0.00	\$0.00	\$26.83	\$36.12
5th 6 months	70.00	\$21.66	\$7.75	\$6.85	\$0.52	\$0.00	\$1.81	\$0.00	\$0.00	\$0.00	\$38.59	\$49.42
6th 6 months	75.00	\$23.21	\$7.75	\$7.34	\$0.52	\$0.00	\$1.94	\$0.00	\$0.00	\$0.00	\$40.76	\$52.36
7th 6 months	80.00	\$24.75	\$7.75	\$7.82	\$0.52	\$0.00	\$2.07	\$0.00	\$0.00	\$0.00	\$42.91	\$55.29
8th 6 months	85.00	\$26.30	\$7.75	\$8.31	\$0.52	\$0.00	\$2.20	\$0.00	\$0.00	\$0.00	\$45.08	\$58.23

Special Calculation Note :

Ratio :
Journeyman to 1 Apprentice

Jurisdiction (* denotes special jurisdictional note)
MEDINA, PORTAGE, SUMMIT

Special Jurisdictional Note :

Details :

Prevailing Wage Rate Skilled Crafts

Name of Union: Carpenter Insulation NE Zone 1A

Change # : LCN01-2020fbLocNEZone1A

Craft : Carpenter Effective Date : 05/28/2020 Last Posted : 05/28/2020

	BHR		Fringe Benefit Payments					Irrevocable Fund		Total PWR	Overtime Rate	
			H&W	Pension	App Tr.	Vac.	Annuity	Other	LECET (*)			MISC (*)
Classification												
Carpenter Insulation	\$24.75		\$7.75	\$9.78	\$0.50	\$0.00	\$2.59	\$0.00	\$0.00	\$0.00	\$45.37	\$57.75
Apprentice	Percent											
1st 3 months	50.00	\$12.38	\$0.00	\$0.00	\$0.00	\$0.00	\$0.00	\$0.00	\$0.00	\$0.00	\$12.38	\$18.56
2nd 3 months	50.00	\$12.38	\$7.75	\$0.00	\$0.50	\$0.00	\$0.00	\$0.00	\$0.00	\$0.00	\$20.62	\$26.81
2nd 6 months	50.00	\$12.38	\$7.75	\$0.00	\$0.50	\$0.00	\$0.00	\$0.00	\$0.00	\$0.00	\$20.62	\$26.81
3rd 6 months	55.00	\$13.61	\$7.75	\$0.00	\$0.50	\$0.00	\$0.00	\$0.00	\$0.00	\$0.00	\$21.86	\$28.67
4th 6 months	60.00	\$14.85	\$7.75	\$0.00	\$0.50	\$0.00	\$0.00	\$0.00	\$0.00	\$0.00	\$23.10	\$30.52
5th 6 months	70.00	\$17.32	\$7.75	\$6.85	\$0.50	\$0.00	\$1.81	\$0.00	\$0.00	\$0.00	\$34.24	\$42.90
6th 6 months	75.00	\$18.56	\$7.75	\$7.34	\$0.50	\$0.00	\$1.94	\$0.00	\$0.00	\$0.00	\$36.09	\$45.37
7th 6 months	80.00	\$19.80	\$7.75	\$7.82	\$0.50	\$0.00	\$2.07	\$0.00	\$0.00	\$0.00	\$37.94	\$47.84
8th 6 months	85.00	\$21.04	\$7.75	\$8.31	\$0.50	\$0.00	\$2.20	\$0.00	\$0.00	\$0.00	\$39.80	\$50.32

Special Calculation Note : No special calculations for this skilled craft wage rate are required at this time.

Ratio :
Journeyman to 1 Apprentice

Jurisdiction (* denotes special jurisdictional note)
MEDINA, PORTAGE, SUMMIT

Special Jurisdictional Note :

Details :

Prevailing Wage Rate

Skilled Crafts

Name of Union: Carpenter Millwright NE Zone M1

Change # : LCN01-2020fbLocNEZoneM1

Craft : Carpenter Effective Date : 05/28/2020 Last Posted : 05/28/2020

	BHR		Fringe Benefit Payments					Irrevocable Fund		Total PWR	Overtime Rate	
			H&W	Pension	App Tr.	Vac.	Annuity	Other	LECET (*)			MISC (*)
Classification												
Carpenter Millwright	\$30.63		\$7.75	\$10.13	\$0.50	\$0.00	\$4.44	\$0.05	\$0.00	\$0.00	\$53.50	\$68.81
Certified Welder	\$31.63		\$7.75	\$10.13	\$0.50	\$0.00	\$4.44	\$0.05	\$0.00	\$0.00	\$54.50	\$70.31
Layout man on Monorail	\$32.38		\$7.75	\$10.13	\$0.50	\$0.00	\$4.44	\$0.05	\$0.00	\$0.00	\$55.25	\$71.44
Apprentice	Percent											
1st 6 months	60.00	\$18.38	\$7.75	\$10.13	\$0.50	\$0.00	\$4.44	\$0.05	\$0.00	\$0.00	\$41.25	\$50.44
2nd 6 months	60.00	\$18.38	\$7.75	\$10.13	\$0.50	\$0.00	\$4.44	\$0.05	\$0.00	\$0.00	\$41.25	\$50.44
3rd 6 months	62.00	\$18.99	\$7.75	\$10.13	\$0.50	\$0.00	\$4.44	\$0.05	\$0.00	\$0.00	\$41.86	\$51.36
4th 6 months	65.50	\$20.06	\$7.75	\$10.13	\$0.50	\$0.00	\$4.44	\$0.05	\$0.00	\$0.00	\$42.93	\$52.96
5th 6 months	69.00	\$21.13	\$7.75	\$10.13	\$0.50	\$0.00	\$4.44	\$0.05	\$0.00	\$0.00	\$44.00	\$54.57
6th 6 months	72.50	\$22.21	\$7.75	\$10.13	\$0.50	\$0.00	\$4.44	\$0.05	\$0.00	\$0.00	\$45.08	\$56.18
7th 6 months	76.00	\$23.28	\$7.75	\$10.13	\$0.50	\$0.00	\$4.44	\$0.05	\$0.00	\$0.00	\$46.15	\$57.79
8th 6 months	80.00	\$24.50	\$7.75	\$10.13	\$0.50	\$0.00	\$4.44	\$0.05	\$0.00	\$0.00	\$47.37	\$59.63

Special Calculation Note : Other \$0.05 is for UBC Millwright Promotional Fund

Ratio :
Journeyman to 1 Apprentice

Jurisdiction (* denotes special jurisdictional note)
ASHLAND, ASHTABULA, CUYAHOGA, ERIE,
GEAUGA, HURON, LAKE, LORAIN, MEDINA,
PORTAGE, RICHLAND, SUMMIT

Special Jurisdictional Note :

Details :
The term "Millwright and Machine Erectors" jurisdiction shall mean the unloading, hoisting, rigging, skidding, moving, dismantling, aligning, erecting, assembling, repairing, maintenance and adjusting of all structures, processing areas either under cover, under ground or elsewhere, required to process material, handle, manufacture or service, be it powered or receiving power manually, by steam, gas, electricity, gasoline, diesel, nuclear, solar, water, air or chemically, and in

Prevailing Wage Rate Skilled Crafts

Name of Union: Carpenter NE District Industrial Dock & Door

Change # : LCN01-2014fbCarpNEStatewide

Craft : Carpenter Effective Date : 03/05/2014 Last Posted : 03/05/2014

	BHR		Fringe Benefit Payments					Irrevocable Fund		Total PWR	Overtime Rate	
			H&W	Pension	App Tr.	Vac.	Annuity	Other	LECET (*)			MISC (*)
Classification												
Carpenter	\$19.70		\$5.05	\$1.00	\$0.15	\$0.00	\$0.00	\$0.00	\$0.00	\$0.00	\$25.90	\$35.75
Trainee	Percent											
1st Year	60.00	\$11.82	\$5.05	\$1.00	\$0.15	\$0.00	\$0.00	\$0.00	\$0.00	\$0.00	\$18.02	\$23.93
2nd Year	80.20	\$15.80	\$5.05	\$1.00	\$0.15	\$0.00	\$0.00	\$0.00	\$0.00	\$0.00	\$22.00	\$29.90

Special Calculation Note : No special calculations for this skilled craft wage rate are required at this time.

Ratio :

1 Journeymen to 1 Trainee

Jurisdiction (* denotes special jurisdictional note) :

- ADAMS, ALLEN, ASHLAND, ASHTABULA,
- ATHENS, AUGLAIZE, BELMONT, BROWN,
- BUTLER, CARROLL, CHAMPAIGN, CLARK,
- CLERMONT, CLINTON, COLUMBIANA,
- COSHOCTON, CRAWFORD, CUYAHOGA,
- DARKE, DEFIANCE, DELAWARE, ERIE,
- FAIRFIELD, FAYETTE, FRANKLIN, FULTON,
- GALLIA, GEAUGA, GREENE, GUERNSEY,
- HAMILTON, HANCOCK, HARDIN,
- HARRISON, HENRY, HIGHLAND, HOCKING,
- HOLMES, HURON, JACKSON, JEFFERSON,
- KNOX, LAKE, LAWRENCE, LICKING, LOGAN,
- LORAIN, LUCAS, MADISON, MAHONING,
- MARION, MEDINA, MEIGS, MERCER, MIAMI,
- MONROE, MONTGOMERY, MORGAN,
- MORROW, MUSKINGUM, NOBLE, OTTAWA,

PAULDING, PERRY, PICKAWAY, PIKE,
PORTAGE, PREBLE, PUTNAM, RICHLAND,
ROSS, SANDUSKY, SCIOTO, SENECA,
SHELBY, STARK, SUMMIT, TRUMBULL,
TUSCARAWAS, UNION, VAN WERT, VINTON,
WARREN, WASHINGTON, WAYNE,
WILLIAMS, WOOD, WYANDOT

Special Jurisdictional Note : Industrial Dock and Door is the installation of overhead doors, roll up doors and dock leveling equipment

Details :

10/27/10 New Contract jc

Prevailing Wage Rate Skilled Crafts

Name of Union: Carpenter Pile Driver NE Zone P1

Change # : LCN01-2020fbLocNEZoneP1

Craft : Carpenter Effective Date : 05/28/2020 Last Posted : 05/28/2020

	BHR		Fringe Benefit Payments					Irrevocable Fund		Total PWR	Overtime Rate	
			H&W	Pension	App Tr.	Vac.	Annuity	Other	LECET (*)			MISC (*)
Classification												
Carpenter Pile Driver	\$30.89		\$7.75	\$10.13	\$0.50	\$0.00	\$4.23	\$0.00	\$0.00	\$0.00	\$53.50	\$68.95
Diver	\$46.34		\$7.75	\$10.13	\$0.50	\$0.00	\$4.23	\$0.00	\$0.00	\$0.00	\$68.95	\$92.12
Certified Welder	\$31.94		\$7.75	\$10.13	\$0.50	\$0.00	\$4.23	\$0.00	\$0.00	\$0.00	\$54.55	\$70.52
Apprentice	Percent											
1st 6 months	60.00	\$18.53	\$7.75	\$10.13	\$0.50	\$0.00	\$4.23	\$0.00	\$0.00	\$0.00	\$41.14	\$50.41
2nd 6 months	60.00	\$18.53	\$7.75	\$10.13	\$0.50	\$0.00	\$4.23	\$0.00	\$0.00	\$0.00	\$41.14	\$50.41
3rd 6 months	62.00	\$19.15	\$7.75	\$10.13	\$0.50	\$0.00	\$4.23	\$0.00	\$0.00	\$0.00	\$41.76	\$51.34
4th 6 months	65.50	\$20.23	\$7.75	\$10.13	\$0.50	\$0.00	\$4.23	\$0.00	\$0.00	\$0.00	\$42.84	\$52.96
5th 6 months	69.00	\$21.31	\$7.75	\$10.13	\$0.50	\$0.00	\$4.23	\$0.00	\$0.00	\$0.00	\$43.92	\$54.58
6th 6 months	72.50	\$22.40	\$7.75	\$10.13	\$0.50	\$0.00	\$4.23	\$0.00	\$0.00	\$0.00	\$45.01	\$56.20
7th 6 months	76.00	\$23.48	\$7.75	\$10.13	\$0.50	\$0.00	\$4.23	\$0.00	\$0.00	\$0.00	\$46.09	\$57.82
8th 6 months	80.00	\$24.71	\$7.75	\$10.13	\$0.50	\$0.00	\$4.23	\$0.00	\$0.00	\$0.00	\$47.32	\$59.68

Special Calculation Note : No special calculations for this skilled craft wage rate are required at this time.

Ratio :
Journeyman to 1 Apprentice

Jurisdiction (* denotes special jurisdictional note)
ASHLAND, ASHTABULA, CUYAHOGA, ERIE,
GEAUGA, HURON, LAKE, LORAIN, MEDINA,
PORTAGE, RICHLAND, SUMMIT

Special Jurisdictional Note :

Details :
Pile Drivers duties shall include but not limited to: Pile driving, milling, fashioning, joining assembling, erecting, fastening, or dismantling of all material of wood, plastic, metal, fiber, cork and composition and all other substitute materials: pile driving, cutting, fitting and placing of lagging, and the handling, cleaning, erecting, installing and dismantling of machinery equipment and erecting pre-engineered metal buildings. Pile Drivers work but not limited to: unloading, assembling, erection, repairs, operation, signaling, dismantling and reloading all equipment that is used for pile driving including pile cutts is defined as sheeting or scrap piling. Underwater work that may be required in connection with the installation of

Prevailing Wage Rate Skilled Crafts

Name of Union: Carpenter Statewide Office Systems

Change # : LCN01-2010jcJurSTWIDEOfficeSystems

Craft : Carpenter Effective Date : 07/27/2010 Last Posted : 07/27/2010

		Fringe Benefit Payments									
		BHR	H&W	Pension	App Tr.	Vac.	Annuity	Other	Total PWR	Overtime Rate	
Classification											
Carpenter Installers		\$16.00	\$5.27	\$1.00	\$0.08	\$0.00	\$0.00	\$0.00	\$22.35	\$30.35	
Helper		\$9.50	\$5.27	\$0.00	\$0.08	\$0.00	\$0.00	\$0.00	\$14.85	\$19.60	
Installer Trainee	Percent										
1st 6 months	59.40	\$9.50	\$5.27	\$0.00	\$0.08	\$0.00	\$0.00	\$0.00	\$14.85	\$19.61	
2nd 6 Months	62.00	\$9.92	\$5.27	\$0.00	\$0.08	\$0.00	\$0.00	\$0.00	\$15.27	\$20.23	
3rd 6 Months	65.00	\$10.40	\$5.27	\$0.00	\$0.08	\$0.00	\$0.00	\$0.00	\$15.75	\$20.95	
4th 6 Months	67.95	\$10.87	\$5.27	\$0.79	\$0.08	\$0.00	\$0.00	\$0.00	\$17.01	\$22.45	
5th 6 months	70.95	\$11.35	\$5.27	\$0.83	\$0.08	\$0.00	\$0.00	\$0.00	\$17.53	\$23.21	
6th 6 Months	73.90	\$11.82	\$5.27	\$0.86	\$0.08	\$0.00	\$0.00	\$0.00	\$18.03	\$23.95	
7th 6 Months	76.90	\$12.30	\$5.27	\$0.90	\$0.08	\$0.00	\$0.00	\$0.00	\$18.55	\$24.71	
8th 6 Months	79.85	\$12.78	\$5.27	\$0.93	\$0.08	\$0.00	\$0.00	\$0.00	\$19.06	\$25.44	
9th 6 months	82.80	\$13.25	\$5.27	\$1.00	\$0.08	\$0.00	\$0.00	\$0.00	\$19.60	\$26.22	

Special Calculation Note : Helper H&W after 90 days probationary period

Ratio :

1 Installer to 1 Trainee or 1 Helper

Jurisdiction (* denotes special jurisdictional note) :

ADAMS, ALLEN, ASHLAND, ASHTABULA, ATHENS, AUGLAIZE, BELMONT, BROWN, BUTLER, CARROLL, CHAMPAIGN, CLARK, CLERMONT, CLINTON, COLUMBIANA, COSHOCTON, CRAWFORD, CUYAHOGA, DARKE, DEFIANCE, DELAWARE, ERIE, FAIRFIELD, FAYETTE, FRANKLIN, FULTON, GALLIA, GEAUGA, GREENE, GUERNSEY, HAMILTON, HANCOCK, HARDIN, HARRISON, HENRY, HIGHLAND, HOCKING, HOLMES, HURON, JACKSON, JEFFERSON, KNOX, LAKE, LAWRENCE, LICKING, LOGAN, LORAIN, LUCAS, MADISON, MAHONING, MARION, MEDINA, MEIGS, MERCER, MIAMI,

MONROE, MONTGOMERY, MORGAN,
MORROW, MUSKINGUM, NOBLE, OTTAWA,
PAULDING, PERRY, PICKAWAY, PIKE,
PORTAGE, PREBLE, PUTNAM, RICHLAND,
ROSS, SANDUSKY, SCIOTO, SENECA,
SHELBY, STARK, SUMMIT, TRUMBULL,
TUSCARAWAS, UNION, VAN WERT, VINTON,
WARREN, WASHINGTON, WAYNE,
WILLIAMS, WOOD, WYANDOT

Special Jurisdictional Note :

Details :

Office systems is defined as modular systems with demountable units such as desks, partitions and shelving. All work in connection with the assembly, reconfiguration and repair of all work in the office system field.

INSTALLER: is defined as a qualified office systems mechanic capable of laying out, estimating and installing various office system manufactured products.

INSTALL TRAINEE: is defined as a person training in the estimating, layout and installation in all facets of the office systems industry. An installer trainee will work to assist an installer or lead installer in all installations. He is NOT permitted to work without the assistance of lead installer

INSTALL HELPER: is defined as a person who assists in the delivery, staging and clean up of related office system work. He is NOT to be involved with the installation or layout of work related to office systems.

Receiving, unloading, unpacking, & removal of rubbish shall be done by install helpers.

Prevailing Wage Rate Skilled Crafts

Name of Union: Cement Mason Bricklayer Local 97 Hwy A

Change # : LCN01-2020fbHvyHwy

Craft : Bricklayer Effective Date : 06/01/2020 Last Posted : 05/21/2020

	BHR		Fringe Benefit Payments					Irrevocable Fund		Total PWR	Overtime Rate	
			H&W	Pension	App Tr.	Vac.	Annuity	Other	LECET (*)	MISC (*)		
Classification												
Cement Mason Bricklayer Sewer Water Works A	\$29.96		\$9.50	\$6.77	\$0.47	\$0.00	\$0.00	\$0.00	\$0.00	\$0.00	\$46.70	\$61.68
Apprentice	Percent											
1st year	50.00	\$14.98	\$9.50	\$6.77	\$0.47	\$0.00	\$0.00	\$0.00	\$0.00	\$0.00	\$31.72	\$39.21
2nd year	70.00	\$20.97	\$9.50	\$6.77	\$0.47	\$0.00	\$0.00	\$0.00	\$0.00	\$0.00	\$37.71	\$48.20
3rd year	90.00	\$26.96	\$9.50	\$6.77	\$0.47	\$0.00	\$0.00	\$0.00	\$0.00	\$0.00	\$43.70	\$57.19

Special Calculation Note : NOT FOR BUILDING CONSTRUCTION.

Ratio :

Journeyman to 1 Apprentice
 Journeyman to 2 Apprentice
 Journeyman to 3 Apprentice
 2 Journeyman to 4 Apprentice
 5 Journeyman to 5 Apprentice

Jurisdiction (* denotes special jurisdictional note) :

ADAMS, ALLEN, ASHLAND, ASHTABULA, ATHENS, AUGLAIZE, BELMONT, BROWN, BUTLER, CARROLL, CHAMPAIGN, CLARK, CLERMONT, CLINTON, COLUMBIANA, COSHOCTON, CRAWFORD, CUYAHOGA, DARKE, DEFIANCE, DELAWARE, ERIE, FAIRFIELD, FAYETTE, FRANKLIN, FULTON, GALLIA, GEAUGA, GREENE, GUERNSEY, HAMILTON, HANCOCK, HARDIN, HARRISON, HENRY, HIGHLAND, HOCKING, HOLMES, HURON, JACKSON, JEFFERSON, KNOX, LAKE, LAWRENCE, LICKING, LOGAN, LORAIN, LUCAS, MADISON, MAHONING, MARION, MEDINA, MEIGS, MERCER, MIAMI, MONROE, MONTGOMERY, MORGAN, MORROW, MUSKINGUM, NOBLE, OTTAWA, PAULDING, PERRY, PICKAWAY, PIKE, PORTAGE, PREBLE, PUTNAM, RICHLAND, ROSS, SANDUSKY, SCIOTO, SENECA, SHELBY, STARK, SUMMIT, TRUMBULL, TUSCARAWAS, UNION, VAN WERT, VINTON, WARREN, WASHINGTON, WAYNE

Special Jurisdictional Note :

Details :

A) Highway Construction, Sewer, Waterworks And Utility Construction, Industrial & Building Site Heavy Construction, Airport Construction Or Railroad Construction Work.
 B) Power Plant, Tunnels, Amusement Park, Athletic Stadium Site Work ,Pollution Control,Sewer Plant, Waste Plant, & Water Treatment Facilities, Construction.

Prevailing Wage Rate Skilled Crafts

Name of Union: Cement Mason Bricklayer Local 97 HevHwy B

Change # : LCN01-2020fbHvyHwy

Craft : Bricklayer Effective Date : 06/01/2020 Last Posted : 05/21/2020

	BHR		Fringe Benefit Payments					Irrevocable Fund		Total PWR	Overtime Rate	
			H&W	Pension	App Tr.	Vac.	Annuity	Other	LECET (*)			MISC (*)
Classification												
Cement Mason Bricklayer Power Plants Tunnels Amusement Parks B	\$30.95		\$9.50	\$6.77	\$0.48	\$0.00	\$0.00	\$0.00	\$0.00	\$0.00	\$47.70	\$63.17
Apprentice	Percent											
1st year	50.00	\$15.48	\$9.50	\$6.77	\$0.48	\$0.00	\$0.00	\$0.00	\$0.00	\$0.00	\$32.23	\$39.96
2nd year	70.00	\$21.66	\$9.50	\$6.77	\$0.48	\$0.00	\$0.00	\$0.00	\$0.00	\$0.00	\$38.42	\$49.25
3rd year	90.00	\$27.85	\$9.50	\$6.77	\$0.48	\$0.00	\$0.00	\$0.00	\$0.00	\$0.00	\$44.60	\$58.53

Special Calculation Note : NOT FOR BUILDING CONSTRUCTION.

Ratio :

- Journeyman to 1 Apprentice
- Journeyman to 2 Apprentice
- Journeyman to 2 Apprentice
- 2 Journeyman to 4 Apprentice
- 5 Journeyman to 5 Apprentice

Jurisdiction (* denotes special jurisdictional note) :

ADAMS, ALLEN, ASHLAND, ASHTABULA, ATHENS, AUGLAIZE, BELMONT, BROWN, BUTLER, CARROLL, CHAMPAIGN, CLARK, CLERMONT, CLINTON, COLUMBIANA, COSHOCTON, CRAWFORD, CUYAHOGA, DARKE, DEFIANCE, DELAWARE, ERIE, FAIRFIELD, FAYETTE, FRANKLIN, FULTON, GALLIA, GEAUGA, GREENE, GUERNSEY, HAMILTON, HANCOCK, HARDIN, HARRISON, HENRY, HIGHLAND, HOCKING, HOLMES, HURON, JACKSON, JEFFERSON, KNOX, LAKE, LAWRENCE, LICKING, LOGAN, LORAIN, LUCAS, MADISON, MAHONING, MARION, MEDINA, MEIGS, MERCER, MIAMI, MONROE, MONTGOMERY, MORGAN, MORROW, MUSKINGUM, NOBLE, OTTAWA, PAULDING, PERRY, PICKAWAY, PIKE, PORTAGE, PREBLE, PUTNAM, RICHLAND, ROSS, SANDUSKY, SCIOTO, SENECA, SHELBY, STARK, SUMMIT, TRUMBULL, TUSCARAWAS, UNION, VAN WERT, VINTON, WARREN, WASHINGTON, WAYNE

Special Jurisdictional Note :

Details :

- A) Highway Construction, Sewer, Waterworks And Utility Construction, Industrial & Building Site Heavy Construction, Airport Construction Or Railroad Construction Work.
- B) Power Plant, Tunnels, Amusement Park, Athletic Stadium Site Work ,Pollution Control,Sewer Plant, Waste Plant, & Water treatment Facilities, Construction.

Plant, Waste Plant, & Water Treatment Facilities, Construction.

Prevailing Wage Rate Skilled Crafts

Name of Union: Cement Mason Statewide HevHwy Exhibit A District II

Change # : LCN01-2020fbCementHevHwy

Craft : Cement Mason Effective Date : 05/01/2020 Last Posted : 04/30/2020

	BHR		Fringe Benefit Payments						Irrevocable Fund		Total PWR	Overtime Rate
			H&W	Pension	App Tr.	Vac.	Annuity	Other	LECET (*)	MISC (*)		
Classification												
Cement Mason	\$30.11		\$8.25	\$7.15	\$0.65	\$0.00	\$2.25	\$0.00	\$0.00	\$0.00	\$48.41	\$63.46
Apprentice												
	Percent											
1st Year	70.00	\$21.08	\$8.25	\$7.15	\$0.65	\$0.00	\$2.25	\$0.00	\$0.00	\$0.00	\$39.38	\$49.92
2nd Year	80.00	\$24.09	\$8.25	\$7.15	\$0.65	\$0.00	\$2.25	\$0.00	\$0.00	\$0.00	\$42.39	\$54.43
3rd Year	90.00	\$27.10	\$8.25	\$7.15	\$0.65	\$0.00	\$2.25	\$0.00	\$0.00	\$0.00	\$45.40	\$58.95

Special Calculation Note : No special calculations for this skilled craft wage rate are required at this time.

Ratio :

1 Journeymen to 1 Apprentice
2 to 1 thereafter

Jurisdiction (* denotes special jurisdictional note) :

BROWN, BUTLER, CLERMONT, COLUMBIANA, DEFIANCE, ERIE, HAMILTON, HIGHLAND, HURON, LORAIN, MAHONING, MEDINA, OTTAWA, PAULDING, PORTAGE, SANDUSKY, SENECA, STARK, SUMMIT, TRUMBULL, WARREN, WILLIAMS

Special Jurisdictional Note : (A) Highway Construction, Sewer, Waterworks And Utility Construction, Industrial & Building Site, Heavy Construction, Airport Construction Or Railroad Construction Work.

Details :

Prevailing Wage Rate

Skilled Crafts

Name of Union: Cement Mason & Plasterer Local 109

Change # : LCN01-2020fbLoc109

Craft : Cement Effective Date : 07/09/2020 Last Posted : 07/09/2020

	BHR		Fringe Benefit Payments					Irrevocable Fund		Total PWR	Overtime Rate	
			H&W	Pension	App Tr.	Vac.	Annuity	Other	LECET (*)			MISC (*)
Classification												
Cement Mason	\$30.04		\$8.89	\$7.15	\$0.40	\$0.00	\$4.25	\$0.06	\$0.00	\$0.00	\$50.79	\$65.81
Plasterer	\$29.33		\$8.39	\$7.15	\$0.40	\$0.00	\$4.00	\$0.06	\$0.00	\$0.00	\$49.33	\$64.00
Apprentice Cement Mason	Percent											
1st year	70.52	\$21.18	\$8.89	\$7.15	\$0.40	\$0.00	\$4.25	\$0.06	\$0.00	\$0.00	\$41.93	\$52.53
2nd year	80.36	\$24.14	\$8.89	\$7.15	\$0.40	\$0.00	\$4.25	\$0.06	\$0.00	\$0.00	\$44.89	\$56.96
3rd year	90.18	\$27.09	\$8.89	\$7.15	\$0.40	\$0.00	\$4.25	\$0.06	\$0.00	\$0.00	\$47.84	\$61.39
Plasterer Apprentice												
1st year	68.89	\$20.69	\$8.39	\$7.15	\$0.40	\$0.00	\$4.00	\$0.06	\$0.00	\$0.00	\$40.69	\$51.04
2nd year	78.45	\$23.57	\$8.39	\$7.15	\$0.40	\$0.00	\$4.00	\$0.06	\$0.00	\$0.00	\$43.57	\$55.35
3rd year	88.05	\$26.45	\$8.39	\$7.15	\$0.40	\$0.00	\$4.00	\$0.06	\$0.00	\$0.00	\$46.45	\$59.68

Special Calculation Note : Other is for International Training.

Ratio :

Journeyman to 1 Apprentice
 Journeyman to 2 Apprentice

Jurisdiction (* denotes special jurisdictional note)

CARROLL, HOLMES, MEDINA, PORTAGE, STARK,
 SUMMIT, TUSCARAWAS, WAYNE

Special Jurisdictional Note :

Details :

Finishers when applying colorshake shall be paid an additional \$2.00 per DAY.
 Working Scaffolds up to 50 feet shall be paid \$0.25 above the Journeyman rate.
 Working Scaffolds over 50 feet shall be paid \$0.35 above the Journeyman rate.

Prevailing Wage Rate Skilled Crafts

Name of Union: Cement Mason Statewide HevHwy Exhibit B District II

Change # : LCN01-2019fbCementHevHwy

Craft : Cement Mason Effective Date : 05/01/2020 Last Posted : 04/30/2020

	BHR		Fringe Benefit Payments					Irrevocable Fund		Total PWR	Overtime Rate	
			H&W	Pension	App Tr.	Vac.	Annuity	Other	LECET (*)			MISC (*)
Classification												
Cement Mason	\$30.98		\$8.25	\$7.15	\$0.65	\$0.00	\$2.25	\$0.00	\$0.00	\$0.00	\$49.28	\$64.77
Apprentice	Percent											
1st Year	70.00	\$21.69	\$8.25	\$7.15	\$0.65	\$0.00	\$2.25	\$0.00	\$0.00	\$0.00	\$39.99	\$50.83
2nd Year	80.00	\$24.78	\$8.25	\$7.15	\$0.65	\$0.00	\$2.25	\$0.00	\$0.00	\$0.00	\$43.08	\$55.48
3rd Year	90.00	\$27.88	\$8.25	\$7.15	\$0.65	\$0.00	\$2.25	\$0.00	\$0.00	\$0.00	\$46.18	\$60.12

Special Calculation Note : No special calculations for this skilled craft wage rate are required at this time.

Ratio :

1 Journeymen to 1 Apprentice
2 to 1 thereafter

Jurisdiction (* denotes special jurisdictional note) :

BROWN, BUTLER, CLERMONT, COLUMBIANA, DEFIANCE, ERIE, HAMILTON, HIGHLAND, HURON, LORAIN, MAHONING, MEDINA, OTTAWA, PAULDING, PORTAGE, SANDUSKY, SENECA, STARK, SUMMIT, TRUMBULL, WARREN, WILLIAMS

Special Jurisdictional Note : (B) Power Plant, Tunnels, Amusement Park, Athletic Stadium Site Work ,Pollution Control,Sewer Plant, Waste Plant, & Water Treatment Facilities, Construction.

Details :

Prevailing Wage Rate Skilled Crafts

Name of Union: Cement Mason Statewide HevHwy Exhibit B District II

Change # : LCN01-2019fbCementHevHwy

Craft : Cement Mason Effective Date : 05/01/2020 Last Posted : 04/30/2020

	BHR		Fringe Benefit Payments						Irrevocable Fund		Total PWR	Overtime Rate
			H&W	Pension	App Tr.	Vac.	Annuity	Other	LECET (*)	MISC (*)		
Classification												
Cement Mason	\$30.98		\$8.25	\$7.15	\$0.65	\$0.00	\$2.25	\$0.00	\$0.00	\$0.00	\$49.28	\$64.77
Apprentice	Percent											
1st Year	70.00	\$21.69	\$8.25	\$7.15	\$0.65	\$0.00	\$2.25	\$0.00	\$0.00	\$0.00	\$39.99	\$50.83
2nd Year	80.00	\$24.78	\$8.25	\$7.15	\$0.65	\$0.00	\$2.25	\$0.00	\$0.00	\$0.00	\$43.08	\$55.48
3rd Year	90.00	\$27.88	\$8.25	\$7.15	\$0.65	\$0.00	\$2.25	\$0.00	\$0.00	\$0.00	\$46.18	\$60.12

Special Calculation Note : No special calculations for this skilled craft wage rate are required at this time.

Ratio :

1 Journeymen to 1 Apprentice
2 to 1 thereafter

Jurisdiction (* denotes special jurisdictional note) :

BROWN, BUTLER, CLERMONT, COLUMBIANA, DEFIANCE, ERIE, HAMILTON, HIGHLAND, HURON, LORAIN, MAHONING, MEDINA, OTTAWA, PAULDING, PORTAGE, SANDUSKY, SENECA, STARK, SUMMIT, TRUMBULL, WARREN, WILLIAMS

Special Jurisdictional Note : (B) Power Plant, Tunnels, Amusement Park, Athletic Stadium Site Work, Pollution Control, Sewer Plant, Waste Plant, & Water Treatment Facilities, Construction.

Details :

Prevailing Wage Rate Skilled Crafts

Name of Union: Electrical Local 306 Inside

Change # : LCN01-2019fbLoc306in

Craft : Electrical Effective Date : 07/10/2019 Last Posted : 07/10/2019

	BHR		Fringe Benefit Payments					Irrevocable Fund		Total PWR	Overtime Rate	
			H&W	Pension	App Tr.	Vac.	Annuity	Other	LECET (*)			MISC (*)
Classification												
Electrician	\$34.89		\$9.71	\$1.05	\$0.70	\$0.00	\$9.00	\$0.00	\$0.00	\$0.00	\$55.35	\$72.79
Electrician w/10 hrs JATC training in the past 12 months	\$35.39		\$9.71	\$1.06	\$0.71	\$0.00	\$9.00	\$0.00	\$0.00	\$0.00	\$55.87	\$73.56
Cable Splicer	\$38.38		\$9.71	\$1.15	\$0.77	\$0.00	\$9.00	\$0.00	\$0.00	\$0.00	\$59.01	\$78.20
Cable Splicer w/10 hrs JATC training in the past 12 months	\$38.93		\$9.71	\$1.17	\$0.78	\$0.00	\$9.00	\$0.00	\$0.00	\$0.00	\$59.59	\$79.05
Apprentice	Percent											
1st period	40.00	\$13.96	\$9.71	\$0.42	\$0.28	\$0.00	\$0.00	\$0.00	\$0.00	\$0.00	\$24.37	\$31.34
2nd period	45.00	\$15.70	\$9.71	\$0.47	\$0.31	\$0.00	\$0.00	\$0.00	\$0.00	\$0.00	\$26.19	\$34.04
3rd period	50.00	\$17.44	\$9.71	\$0.52	\$0.35	\$0.00	\$4.50	\$0.00	\$0.00	\$0.00	\$32.53	\$41.25
4th period	55.00	\$19.19	\$9.71	\$0.58	\$0.38	\$0.00	\$4.95	\$0.00	\$0.00	\$0.00	\$34.81	\$44.40
5th period	65.00	\$22.68	\$9.71	\$0.68	\$0.45	\$0.00	\$5.85	\$0.00	\$0.00	\$0.00	\$39.37	\$50.71
6th period	80.00	\$27.91	\$9.71	\$0.84	\$0.56	\$0.00	\$7.20	\$0.00	\$0.00	\$0.00	\$46.22	\$60.18

Special Calculation Note :

Ratio :

- Each job site
- 2 Apprentices to 3 Journeymen or fraction thereof:
- 1 - 3 Journeymen to 2 Apprentice
- 4 - 6 Journeymen to 4 Apprentice
- 7 - 9 Journeymen to 6 Apprentice
- 10-12 Journeymen to 8 Apprentice
- 13-15 Journeymen to 10 Apprentice

Jurisdiction (* denotes special jurisdictional note):

MEDINA*, PORTAGE*, SUMMIT, WAYNE*

First person assigned to a job site shall be a Journeyman Wireman

Special Jurisdictional Note :

Medina County the following townships are included: (Brunswick, Chatham, Granger, Guilford, Harrisville, Hinckley, Homer, Lafayette, Medina, Montville, Sharon, Spencer, Wadsworth, Westfield and York).

Portage County the following townships are included: (Atwater, Aurora, Brimfield, Deerfield, Franklin, Mantua, Randolph, Ravenna, Rootstown, Shalersville, Streetsboro and Suffield).

Wayne County the following townships are included: (Baughman, Cannaan, Chester, Chippewa, Congress, Green, Milton, and Wayne).

Details :

This rate covers both Commercial and Industrial. High work a premium rate of shall be paid at (3%) per hour for all work performed over (30') free-fall and for work in a mine. Line work is excluded.

Prevailing Wage Rate Skilled Crafts

Name of Union: Electrical Local 306 Inside Lt Commercial Northern

Change # : LCN01-2021fbLoc306in

Craft : Electrical Effective Date : 01/27/2021 Last Posted : 01/27/2021

	BHR		Fringe Benefit Payments					Irrevocable Fund		Total PWR	Overtime Rate	
			H&W	Pension	App Tr.	Vac.	Annuity	Other	LECET (*)			MISC (*)
Classification												
Electrician	\$35.89		\$9.40	\$1.08	\$0.72	\$0.00	\$9.00	\$0.81	\$0.00	\$0.00	\$56.90	\$74.84
Electrician w/10 hrs JATC training in the past 12 months	\$36.39		\$9.40	\$1.09	\$0.73	\$0.00	\$9.00	\$0.81	\$0.00	\$0.00	\$57.42	\$75.62
Cable Splicer	\$39.48		\$9.40	\$1.18	\$0.79	\$0.00	\$9.00	\$0.81	\$0.00	\$0.00	\$60.66	\$80.40
Cable Splicer w/10 hrs JATC training in the past 12 months	\$40.03		\$9.40	\$1.20	\$0.80	\$0.00	\$9.00	\$0.81	\$0.00	\$0.00	\$61.24	\$81.26
CE-3 12,001-14,000 Hrs	\$26.31		\$6.35	\$0.79	\$0.84	\$0.00	\$0.77	\$0.10	\$0.00	\$0.00	\$35.16	\$48.32
CE-2 10,001-12,000 Hrs	\$20.67		\$6.35	\$0.62	\$0.84	\$0.00	\$0.60	\$0.10	\$0.00	\$0.00	\$29.18	\$39.52
CE-1 8,001-10,000 Hrs	\$18.79		\$6.35	\$0.56	\$0.84	\$0.00	\$0.55	\$0.10	\$0.00	\$0.00	\$27.19	\$36.59
CW-4 6,001-8,000 Hrs	\$16.91		\$6.35	\$0.51	\$0.84	\$0.00	\$0.49	\$0.10	\$0.00	\$0.00	\$25.20	\$33.66
CW-3 4,001-6,000 Hrs	\$15.03		\$6.35	\$0.45	\$0.84	\$0.00	\$0.44	\$0.10	\$0.00	\$0.00	\$23.21	\$30.72
CW-2 2,001-4,000 Hrs	\$14.09		\$6.35	\$0.42	\$0.84	\$0.00	\$0.41	\$0.10	\$0.00	\$0.00	\$22.21	\$29.26
CW-1 0-2,000 Hrs	\$13.15		\$6.35	\$0.39	\$0.84	\$0.00	\$0.38	\$0.10	\$0.00	\$0.00	\$21.21	\$27.79
Apprentice	Percent											
1st period	40.00	\$14.36	\$9.40	\$0.43	\$0.29	\$0.00	\$0.00	\$0.81	\$0.00	\$0.00	\$25.29	\$32.46

2nd period	45.00	\$16.15	\$9.40	\$0.48	\$0.32	\$0.00	\$0.00	\$0.81	\$0.00	\$0.00	\$27.16	\$35.24
3rd period	50.00	\$17.94	\$9.40	\$0.54	\$0.36	\$0.00	\$4.50	\$0.81	\$0.00	\$0.00	\$33.56	\$42.53
4th period	55.00	\$19.74	\$9.40	\$0.59	\$0.39	\$0.00	\$4.95	\$0.81	\$0.00	\$0.00	\$35.88	\$45.75
5th period	65.00	\$23.33	\$9.40	\$0.70	\$0.47	\$0.00	\$5.85	\$0.81	\$0.00	\$0.00	\$40.56	\$52.22
6th period	80.00	\$28.71	\$9.40	\$0.86	\$0.57	\$0.00	\$7.20	\$0.81	\$0.00	\$0.00	\$47.55	\$61.91

Special Calculation Note : Other is for Retirement Health and Welfare and Administration Fund for CE/CW.

Ratio :

- Each job site
- 2 Apprentices to 3 Journeymen or fraction thereof:
- 1 - 3 Journeymen to 2 Apprentice
- 4 - 6 Journeymen to 4 Apprentice
- 7 - 9 Journeymen to 6 Apprentice
- 10-12 Journeymen to 8 Apprentice
- 13-15 Journeymen to 10 Apprentice

Jurisdiction (* denotes special jurisdictional note) :

MEDINA*, PORTAGE*, SUMMIT, WAYNE*

First person assigned to a job site shall be a Journeyman Wireman

Construction Electrician and Construction Wireman Ratio
 There shall be a minimum ratio of one inside Journeyman Wireman to every (4) employees of different classifications per jobsite. An Inside Journeyman Wireman is required on the project as the fifth (5th) worker or when apprentices are used.

Special Jurisdictional Note :

Medina County the following townships are included: (Brunswick, Chatham, Granger, Guilford, Harrisville, Hinckley, Homer, Lafayette, Medina, Montville, Sharon, Spencer, Wadsworth, Westfield and York).
 Portage County the following townships are included: (Atwater, Aurora, Brimfield, Deerfield, Franklin, Mantua, Randolph, Ravenna, Rootstown, Shalersville, Streetsboro and Suffield).
 Wayne County the following townships are included: (Baughman, Cannaan, Chester, Chippewa, Congress, Green, Milton, and Wayne).

The scope of work for the light commercial agreement shall apply to the following small medical clinics, stand-alone doctor and dentist offices with up to 600 amp service (not attached to a hospital), gas stations/convenience stores, fast food restaurants and franchised chain restaurants including independent bars and taverns, places of worship, funeral homes, nursing homes, assisted living facilities and day-care facilities under 15,000 sq ft, small office, retail/wholesale facilities under 15,000 sq ft with less than 10 units attached, storage units, car washes, express hotels and motels (4 stories or less) without conference or restaurants facilities, residential units (subject to Davis Bacon Rates) small stand-alone manufacturing facilities when free standing and not part of a larger facility (less than 15,000 sq ft) solar projects (500 panels or less) unless other wise covered under this agreement, lighting retrofits (when not associated with remodels involving branch re-circuiting) Lighting retrofits shall be defined as the changing of lamps and ballasts in existing light fixtures and shall also include the one for one replacement of existing fixtures.

Details :

This rate covers both Commercial and Industrial. High work a premium rate of shall be paid at (3%) per hour for all work performed over (30') free-fall and for work in a mine. Line work is excluded.

Prevailing Wage Rate Skilled Crafts

Name of Union: Electrical Local 306 Lightning Rod

Change # : LCN01-2019fbLoc306VDV

Craft : Voice Data Video Effective Date : 07/10/2019 Last Posted : 07/10/2019

	BHR		Fringe Benefit Payments					Irrevocable Fund		Total PWR	Overtime Rate	
			H&W	Pension	App Tr.	Vac.	Annuity	Other	LECET (*)			MISC (*)
Classification												
Electrical Lightning Protection Installer	\$29.50		\$7.50	\$0.89	\$0.00	\$2.09	\$1.77	\$0.00	\$0.00	\$0.00	\$41.75	\$56.50
Apprentice	Percent											
1st Day- 6 months	50.00	\$14.75	\$7.50	\$0.44	\$0.00	\$0.00	\$0.89	\$0.39	\$0.00	\$0.00	\$23.97	\$31.35
2nd 6 months	55.00	\$16.23	\$7.50	\$0.49	\$0.00	\$0.00	\$0.97	\$0.43	\$0.00	\$0.00	\$25.61	\$33.73
3rd 6 months	60.00	\$17.70	\$7.50	\$0.53	\$0.00	\$0.87	\$1.06	\$0.00	\$0.00	\$0.00	\$27.66	\$36.51
4th 6 months	65.00	\$19.17	\$7.50	\$0.58	\$0.00	\$0.94	\$1.15	\$0.00	\$0.00	\$0.00	\$29.34	\$38.93
3rd Year	70.00	\$20.65	\$7.50	\$0.62	\$0.00	\$1.47	\$1.24	\$0.00	\$0.00	\$0.00	\$31.48	\$41.80
4th Year	80.00	\$23.60	\$7.50	\$0.71	\$0.00	\$1.68	\$1.42	\$0.00	\$0.00	\$0.00	\$34.91	\$46.71
5th Year	90.00	\$26.55	\$7.50	\$0.80	\$0.00	\$1.89	\$1.59	\$0.00	\$0.00	\$0.00	\$38.33	\$51.61

Special Calculation Note : Other is Holiday

Ratio :

1 Journeyman to 1 Apprentice

Jurisdiction (* denotes special jurisdictional note) :

MEDINA*, PORTAGE*, SUMMIT, WAYNE*

Special Jurisdictional Note : In Medina County the following townships are included: (Brunswick, Chatham, Granger, Guilford, Harrisville, Hinckley, Homer, Lafayette, Medina, Montville, Sharon, Spencer, Wadsworth, Westfield and York). In Portage County the following townships are included: (Atwater, Aurora, Brimfield, Deerfield, Franklin, Mantua, Randolph, Ravenna, Rootstown, Shalersville, Streetsboro and Suffield). In Wayne County the following townships are included: (Baughman, Canaan, Chester, Chippewa, Congress, Green, Milton, and Wayne).

Details :

Prevailing Wage Rate Skilled Crafts

Name of Union: Electrical Local 306 Inside

Change # : LCN01-2020fbLoc306in

Draft : Electrical Effective Date : 06/25/2020 Last Posted : 06/25/2020

	BHR		Fringe Benefit Payments					Irrevocable Fund		Total PWR	Overtime Rate	
			H&W	Pension	App Tr.	Vac.	Annuity	Other	LECET (*)			MISC (*)
Classification												
Electrician	\$35.89		\$10.21	\$1.08	\$0.72	\$0.00	\$9.00	\$0.00	\$0.00	\$0.00	\$56.90	\$74.84
Electrician w/10 hrs ATC training in the past 12 months	\$36.39		\$10.21	\$1.09	\$0.73	\$0.00	\$9.00	\$0.00	\$0.00	\$0.00	\$57.42	\$75.62
Cable Splicer	\$39.48		\$10.21	\$1.18	\$0.79	\$0.00	\$9.00	\$0.00	\$0.00	\$0.00	\$60.66	\$80.40
Cable Splicer w/10 hrs ATC training in the past 12 months	\$40.03		\$10.21	\$1.20	\$0.80	\$0.00	\$9.00	\$0.00	\$0.00	\$0.00	\$61.24	\$81.25
Apprentice	Percent											
1st period	40.00	\$14.36	\$10.21	\$0.43	\$0.29	\$0.00	\$0.00	\$0.00	\$0.00	\$0.00	\$25.29	\$32.46
2nd period	45.00	\$16.15	\$10.21	\$0.48	\$0.32	\$0.00	\$0.00	\$0.00	\$0.00	\$0.00	\$27.16	\$35.24
3rd period	50.00	\$17.94	\$10.21	\$0.54	\$0.36	\$0.00	\$4.50	\$0.00	\$0.00	\$0.00	\$33.56	\$42.53
4th period	55.00	\$19.74	\$10.21	\$0.59	\$0.39	\$0.00	\$4.95	\$0.00	\$0.00	\$0.00	\$35.88	\$45.75
5th period	65.00	\$23.33	\$10.21	\$0.70	\$0.47	\$0.00	\$5.85	\$0.00	\$0.00	\$0.00	\$40.56	\$52.22
6th period	80.00	\$28.71	\$10.21	\$0.86	\$0.57	\$0.00	\$7.20	\$0.00	\$0.00	\$0.00	\$47.55	\$61.91

Special Calculation Note :

Ratio :

- 3 Journeymen to 2 Apprentice
- 6 Journeymen to 4 Apprentice
- 9 Journeymen to 6 Apprentice
- 10-12 Journeymen to 8 Apprentice
- 13-15 Journeymen to 10 Apprentice

Jurisdiction (* denotes special jurisdictional note) :

MEDINA*, PORTAGE*, SUMMIT, WAYNE*

The first person assigned to a job site shall be a Journeyman Wireman

Special Jurisdictional Note :

Medina County the following townships are included: (Brunswick, Chatham, Granger, Guilford, Harrisville, Hinckley, Homer, Lafayette, Medina, Montville, Sharon, Spencer, Wadsworth, Westfield and York).

Portage County the following townships are included: (Atwater, Aurora, Brimfield, Deerfield, Franklin, Mantua, Randolph, Ravenna, Rootstown, Shalersville, Streetsboro and Suffield).

Wayne County the following townships are included: (Baughman, Canaan, Chester, Chippewa, Congress, Green, Milton, and Wayne).

Details :

This rate covers both Commercial and Industrial. High work a premium rate of shall be paid at (3%) per hour for all work performed over

Prevailing Wage Rate

Skilled Crafts

Name of Union: Electrical Local 306 Inside Lt Commercial Northern

Change # : LCN02-2020fbLoc306in

Craft : Electrical Effective Date : 06/25/2020 Last Posted : 06/25/2020

	BHR		Fringe Benefit Payments					Irrevocable Fund		Total PWR	Overtime Rate	
			H&W	Pension	App Tr.	Vac.	Annuity	Other	LECET (*)			MISC (*)
Classification												
Electrician	\$35.89		\$9.40	\$1.08	\$0.72	\$0.00	\$9.00	\$0.81	\$0.00	\$0.00	\$56.90	\$74.84
Electrician w/10 hrs IATC training in the past 12 months	\$36.39		\$9.40	\$1.09	\$0.73	\$0.00	\$9.00	\$0.81	\$0.00	\$0.00	\$57.42	\$75.62
Cable Splicer	\$39.48		\$9.40	\$1.18	\$0.79	\$0.00	\$9.00	\$0.81	\$0.00	\$0.00	\$60.66	\$80.40
Cable Splicer w/10 hrs IATC training in the past 12 months	\$40.03		\$9.40	\$1.20	\$0.80	\$0.00	\$9.00	\$0.81	\$0.00	\$0.00	\$61.24	\$81.26
CE-3 12,001- 14,000 Hrs	\$25.63		\$6.15	\$0.77	\$0.83	\$0.00	\$0.77	\$0.10	\$0.00	\$0.00	\$34.25	\$47.07
CE-2 10,001- 12,000 Hrs	\$20.14		\$6.15	\$0.60	\$0.83	\$0.00	\$0.60	\$0.10	\$0.00	\$0.00	\$28.42	\$38.49
CE-1 3,001- 10,000 Hrs	\$18.31		\$6.15	\$0.55	\$0.83	\$0.00	\$0.55	\$0.10	\$0.00	\$0.00	\$26.49	\$35.64
CW-4 5,001- 3,000 Hrs	\$16.48		\$6.15	\$0.49	\$0.83	\$0.00	\$0.49	\$0.10	\$0.00	\$0.00	\$24.54	\$32.78
CW-3 4,001- 5,000 Hrs	\$14.65		\$6.15	\$0.44	\$0.83	\$0.00	\$0.44	\$0.10	\$0.00	\$0.00	\$22.61	\$29.94
CW-2 2,001- 4,000 Hrs	\$13.73		\$6.15	\$0.41	\$0.83	\$0.00	\$0.41	\$0.10	\$0.00	\$0.00	\$21.63	\$28.49
CW-1 0- 2,000 Hrs	\$12.82		\$6.15	\$0.38	\$0.83	\$0.00	\$0.38	\$0.10	\$0.00	\$0.00	\$20.66	\$27.07
Apprentice	Percent											
1st period	40.00	\$14.36	\$9.40	\$0.43	\$0.29	\$0.00	\$0.00	\$0.81	\$0.00	\$0.00	\$25.29	\$32.46
2nd period	45.00	\$16.15	\$9.40	\$0.48	\$0.32	\$0.00	\$0.00	\$0.81	\$0.00	\$0.00	\$27.16	\$35.24
3rd period	50.00	\$17.94	\$9.40	\$0.54	\$0.36	\$0.00	\$0.00	\$0.81	\$0.00	\$0.00	\$29.03	\$38.02

Prevailing Wage Rate Skilled Crafts

Name of Union: Electrical Local 306 Voice Data Video

Change # : LCN01-2021fbLoc306VDV

Craft : Voice Data Video Effective Date : 01/27/2021 Last Posted : 01/27/2021

	BHR		Fringe Benefit Payments					Irrevocable Fund		Total PWR	Overtime Rate	
			H&W	Pension	App Tr.	Vac.	Annuity	Other	LECET (*)			MISC (*)
Classification												
Electrical Installer Technician	\$25.25		\$8.62	\$0.79	\$0.40	\$1.14	\$2.75	\$0.51	\$0.00	\$0.00	\$39.46	\$52.08
Cable Puller	\$14.39		\$8.62	\$0.45	\$0.23	\$0.65	\$1.57	\$0.51	\$0.00	\$0.00	\$26.42	\$33.61
Journeyman/Tech with 10 Hrs of Journeyman Training	\$25.75		\$8.62	\$0.81	\$0.40	\$1.16	\$2.75	\$0.51	\$0.00	\$0.00	\$40.00	\$52.87
Apprentice	Percent											
1st Period	60.00	\$15.15	\$8.62	\$0.45	\$0.23	\$0.68	\$1.65	\$0.51	\$0.00	\$0.00	\$27.29	\$34.86
2nd Period	62.92	\$15.89	\$8.62	\$0.48	\$0.24	\$0.74	\$1.79	\$0.51	\$0.00	\$0.00	\$28.27	\$36.21
3rd Period	72.65	\$18.34	\$8.62	\$0.55	\$0.28	\$0.85	\$2.06	\$0.51	\$0.00	\$0.00	\$31.21	\$40.39
4th Period	77.48	\$19.56	\$8.62	\$0.59	\$0.29	\$0.97	\$2.34	\$0.51	\$0.00	\$0.00	\$32.88	\$42.67

Special Calculation Note : Other is Retiree Health Fund.

Ratio :
1 Journeyman to 1 Apprentice

Jurisdiction (* denotes special jurisdictional note) :
MEDINA*, PORTAGE*, SUMMIT, WAYNE*

Special Jurisdictional Note : In Medina County the following townships are included: Brunswick, Chatham, Granger, Guilford, Harrisville, Hinckley, Homer, Lafayette, Medina, Montville, Sharon, Spencer, Wadsworth, Westfield and York.

In Portage County the following townships are included: Atwater, Aurora, Brimfield, Deerfield, Franklin, Mantua, Randolph, Ravenna, Rootstown, Shalersville, Streetsboro and Suffield.

In Wayne County the following townships are included: Baughman, Cannaan, Chester, Chippewa, Congress, Green, Milton, and Wayne.

Details :

The following work is EXCLUDED from the Teledata Technician scope of work:

Installation of computer systems in industrial applications such as assembly lines, robotics, computer controller manufacturing systems.

Installation of conduit and/or raceways shall be installed by Inside Wireman . On sites where there is no Inside Wireman employed, the Teledata Technician may install raceway or conduit not greater than 10 foot.

Fire Alarm work is excluded on all new construction sites or wherever the fire alarm system is installed in conduit.

All HVAC control work.

Prevailing Wage Rate Skilled Crafts

Name of Union: Electrical Local 71 High Tension Pipe Type Cable

Change # : LCN01-2019fbLoc7

Craft : Lineman Effective Date : 04/24/2019 Last Posted : 04/24/2019

	BHR		Fringe Benefit Payments					Irrevocable Fund		Total PWR	Overtime Rate	
			H&W	Pension	App Tr.	Vac.	Annuity	Other	LECET (*)			MISC (*)
Classification												
Electrical Lineman	\$43.48		\$6.00	\$1.30	\$0.43	\$0.00	\$10.00	\$0.35	\$0.00	\$0.00	\$61.56	\$83.30
Certified Lineman Welder	\$43.48		\$6.00	\$1.30	\$0.43	\$0.00	\$10.00	\$0.35	\$0.00	\$0.00	\$61.56	\$83.30
Certified Cable Splicer	\$43.48		\$6.00	\$1.30	\$0.43	\$0.00	\$10.00	\$0.35	\$0.00	\$0.00	\$61.56	\$83.30
Operator A	\$39.02		\$6.00	\$1.17	\$0.39	\$0.00	\$8.97	\$0.35	\$0.00	\$0.00	\$55.90	\$75.41
Operator B	\$34.60		\$6.00	\$1.04	\$0.35	\$0.00	\$7.96	\$0.35	\$0.00	\$0.00	\$50.30	\$67.60
Operator C	\$27.93		\$6.00	\$0.84	\$0.28	\$0.00	\$6.42	\$0.35	\$0.00	\$0.00	\$41.82	\$55.79
Groundman 0-12 months Exp	\$21.74		\$6.00	\$0.65	\$0.22	\$0.00	\$5.00	\$0.35	\$0.00	\$0.00	\$33.96	\$44.83
Groundman 0-12 months Exp w/CDL	\$23.91		\$6.00	\$0.72	\$0.24	\$0.00	\$5.50	\$0.35	\$0.00	\$0.00	\$36.72	\$48.68
Groundman 1 yr or more	\$23.91		\$6.00	\$0.72	\$0.24	\$0.00	\$5.50	\$0.35	\$0.00	\$0.00	\$36.72	\$48.68
Groundman 1 yr or more w/CDL	\$28.26		\$6.00	\$0.85	\$0.28	\$0.00	\$6.50	\$0.35	\$0.00	\$0.00	\$42.24	\$56.37
Equipment Mechanic A	\$34.60		\$6.00	\$1.04	\$0.35	\$0.00	\$7.96	\$0.35	\$0.00	\$0.00	\$50.30	\$67.60
Equipment Mechanic B	\$31.26		\$6.00	\$0.94	\$0.31	\$0.00	\$7.19	\$0.35	\$0.00	\$0.00	\$46.05	\$61.68
Equipment Mechanic C	\$27.93		\$6.00	\$0.84	\$0.28	\$0.00	\$6.42	\$0.35	\$0.00	\$0.00	\$41.82	\$55.79
X-Ray Technician	\$43.48		\$6.00	\$1.30	\$0.43	\$0.00	\$10.00	\$0.35	\$0.00	\$0.00	\$61.56	\$83.30
Apprentice	Percent											
1st 1000	60.00	\$26.09	\$6.00	\$0.78	\$0.26	\$0.00	\$6.00	\$0.35	\$0.00	\$0.00	\$39.48	\$52.52

hrs												
2nd 1000 hrs	65.00	\$28.26	\$6.00	\$0.85	\$0.28	\$0.00	\$6.50	\$0.35	\$0.00	\$0.00	\$42.24	\$56.37
3rd 1000 hrs	70.00	\$30.44	\$6.00	\$0.91	\$0.30	\$0.00	\$7.00	\$0.35	\$0.00	\$0.00	\$45.00	\$60.21
4th 1000 hrs	75.00	\$32.61	\$6.00	\$0.98	\$0.33	\$0.00	\$7.50	\$0.35	\$0.00	\$0.00	\$47.77	\$64.07
5th 1000 hrs	80.00	\$34.78	\$6.00	\$1.04	\$0.35	\$0.00	\$8.00	\$0.35	\$0.00	\$0.00	\$50.52	\$67.92
6th 1000 hrs	85.00	\$36.96	\$6.00	\$1.11	\$0.37	\$0.00	\$8.50	\$0.35	\$0.00	\$0.00	\$53.29	\$71.77
7th 1000 hrs	90.00	\$39.13	\$6.00	\$1.17	\$0.39	\$0.00	\$9.00	\$0.35	\$0.00	\$0.00	\$56.04	\$75.61

Special Calculation Note : Other is Health Retirement Account

Operator "A"

John Henry Rock Drill, D-6 (or equivalent) and above, Trackhoe Digger, (320 Track excavator), Cranes (greater than 25 tons and less than 45 tons).

Operator "B"

Cranes (greater than 6 tons and up to 25 tons), Backhoes, Road Tractor, Dozer up to D-5, Pressure Digger-wheeled or tracked, all Tension wire Stringing equipment.

Operator "C"

Trench, Backhoe, Riding type vibratory Compactor, Ground Rod Driver, Boom Truck (6 ton & below), Skid Steer Loaders, Material Handler.

*All Operators of cranes 45 ton or larger shall be paid the journeyman rate of pay. \$0.30 is for Health Retirement Account.

Ratio :

1 Journeyman to 1 Apprentice

Jurisdiction (* denotes special jurisdictional note) :

ADAMS, ASHLAND, ASHTABULA, ATHENS, AUGLAIZE, BELMONT, BROWN, BUTLER, CARROLL, CHAMPAIGN, CLARK, CLERMONT, CLINTON, COLUMBIANA, COSHOCTON, CRAWFORD, CUYAHOGA, DARKE, DELAWARE, FAIRFIELD, FAYETTE, FRANKLIN, GALLIA, GEAUGA, GREENE, GUERNSEY, HAMILTON, HARRISON, HIGHLAND, HOCKING, HOLMES, JACKSON, JEFFERSON, KNOX, LAKE, LAWRENCE, LICKING, LOGAN, LORAIN, MADISON, MAHONING, MARION, MEDINA, MEIGS, MERCER, MIAMI, MONROE, MONTGOMERY, MORGAN, MORROW, MUSKINGUM, NOBLE, PERRY, PICKAWAY, PIKE, PORTAGE, PREBLE, RICHLAND, ROSS, SCIOTO, SHELBY, STARK, SUMMIT, TRUMBULL, TUSCARAWAS, UNION, VINTON, WARREN, WASHINGTON, WAYNE

Special Jurisdictional Note :

Details :

Heli - Arc Welding will be paid \$.30 above Journeyman rate. Additional compensation of 10% over the Journeyman Lineman and Journeyman Technician for performing work on structures outside of buildings such as water towers, smoke stacks, radio and television towers, more than 75' above the ground.

Prevailing Wage Rate Skilled Crafts

Name of Union: Electrical Local 71 Outside Utility Power

Change # : LCN01-2019fbLoc7

Craft : Lineman Effective Date : 04/24/2019 Last Posted : 04/24/2019

	BHR		Fringe Benefit Payments					Irrevocable Fund		Total PWR	Overtime Rate	
			H&W	Pension	App Tr.	Vac.	Annuity	Other	LECET (*)			MISC (*)
Classification												
Electrical Lineman	\$41.22		\$6.00	\$1.24	\$0.41	\$0.00	\$9.48	\$0.35	\$0.00	\$0.00	\$58.70	\$79.31
Substation Technician	\$41.22		\$6.00	\$1.24	\$0.41	\$0.00	\$9.48	\$0.35	\$0.00	\$0.00	\$58.70	\$79.31
Cable Splicer	\$43.14		\$6.00	\$1.29	\$0.43	\$0.00	\$9.92	\$0.35	\$0.00	\$0.00	\$61.13	\$82.70
Operator A	\$37.00		\$6.00	\$1.11	\$0.37	\$0.00	\$8.51	\$0.35	\$0.00	\$0.00	\$53.34	\$71.84
Operator B	\$32.78		\$6.00	\$0.98	\$0.33	\$0.00	\$7.54	\$0.35	\$0.00	\$0.00	\$47.98	\$64.37
Operator C	\$26.44		\$6.00	\$0.79	\$0.26	\$0.00	\$6.08	\$0.35	\$0.00	\$0.00	\$39.92	\$53.14
Groundman 0-12 months Exp	\$20.61		\$6.00	\$0.62	\$0.21	\$0.00	\$4.74	\$0.35	\$0.00	\$0.00	\$32.53	\$42.84
Groundman 0-12 months Exp w/CDL	\$22.67		\$6.00	\$0.68	\$0.23	\$0.00	\$5.21	\$0.35	\$0.00	\$0.00	\$35.14	\$46.48
Groundman 1 yr or more	\$22.67		\$6.00	\$0.68	\$0.23	\$0.00	\$5.21	\$0.35	\$0.00	\$0.00	\$35.14	\$46.48
Groundman 1 yr or more w/CDL	\$26.80		\$6.00	\$0.80	\$0.27	\$0.00	\$6.16	\$0.35	\$0.00	\$0.00	\$40.38	\$53.78
Equipment Mechanic A	\$32.78		\$6.00	\$0.98	\$0.33	\$0.00	\$7.54	\$0.35	\$0.00	\$0.00	\$47.98	\$64.37
Equipment Mechanic B	\$29.62		\$6.00	\$0.89	\$0.30	\$0.00	\$6.81	\$0.35	\$0.00	\$0.00	\$43.97	\$58.78
Equipment Mechanic C	\$26.44		\$6.00	\$0.79	\$0.26	\$0.00	\$6.08	\$0.35	\$0.00	\$0.00	\$39.92	\$53.14
Line Truck w/uuger	\$29.17		\$6.00	\$0.88	\$0.29	\$0.00	\$6.71	\$0.35	\$0.00	\$0.00	\$43.40	\$57.99
Apprentice	Percent											
1st 1000 hrs	60.00	\$24.73	\$6.00	\$0.74	\$0.25	\$0.00	\$5.69	\$0.35	\$0.00	\$0.00	\$37.76	\$50.13
2nd 1000	65.00	\$26.79	\$6.00	\$0.80	\$0.27	\$0.00	\$6.16	\$0.35	\$0.00	\$0.00	\$40.37	\$53.77

hrs												
3rd 1000 hrs	70.00	\$28.85	\$6.00	\$0.87	\$0.29	\$0.00	\$6.64	\$0.35	\$0.00	\$0.00	\$43.00	\$57.43
4th 1000 hrs	75.00	\$30.91	\$6.00	\$0.93	\$0.31	\$0.00	\$7.11	\$0.35	\$0.00	\$0.00	\$45.62	\$61.07
5th 1000 hrs	80.00	\$32.98	\$6.00	\$0.99	\$0.33	\$0.00	\$7.59	\$0.35	\$0.00	\$0.00	\$48.24	\$64.72
6th 1000 hrs	85.00	\$35.04	\$6.00	\$1.05	\$0.35	\$0.00	\$8.06	\$0.35	\$0.00	\$0.00	\$50.85	\$68.37
7th 1000 hrs	90.00	\$37.10	\$6.00	\$1.11	\$0.37	\$0.00	\$8.53	\$0.35	\$0.00	\$0.00	\$53.46	\$72.01

Special Calculation Note : Other is Health Retirement Account

Operator "A"

John Henry Rock Drill, D-6 (or equivalent) and above, Trackhoe Digger, (320 Track excavator), Cranes (greater than 25 tons and less than 45 tons).

Operator "B"

Cranes (greater than 6 tons and up to 25 tons), Backhoes, Road Tractor, Dozer up to D-5, Pressure Digger-wheeled or tracked, all Tension wire Stringing equipment.

Operator "C"

Trench, Backhoe, Riding type vibratory Compactor, Ground Rod Driver, Boom Truck (6 ton & below), Skid Steer Loaders, Material Handler.

Ratio :

(1) Journeyman Lineman to (1) Apprentice

Jurisdiction (* denotes special jurisdictional note) :

ADAMS, ASHLAND, ASHTABULA, ATHENS, AUGLAIZE, BELMONT, BROWN, BUTLER, CARROLL, CHAMPAIGN, CLARK, CLERMONT, CLINTON, COLUMBIANA, COSHOCTON, CRAWFORD, CUYAHOGA, DARKE, DELAWARE, FAIRFIELD, FAYETTE, FRANKLIN, GALLIA, GEAUGA, GREENE, GUERNSEY, HAMILTON, HARRISON, HIGHLAND, HOCKING, HOLMES, JACKSON, JEFFERSON, KNOX, LAKE, LAWRENCE, LICKING, LOGAN, LORAIN, MADISON, MAHONING, MARION, MEDINA, MEIGS, MERCER, MIAMI, MONROE, MONTGOMERY, MORGAN, MORROW, MUSKINGUM, NOBLE, PERRY, PICKAWAY, PIKE, PORTAGE, PREBLE, RICHLAND, ROSS, SCIOTO, SHELBY, STARK, SUMMIT, TRUMBULL, TUSCARAWAS, UNION, VINTON, WARREN, WASHINGTON, WAYNE

Special Jurisdictional Note : 0.30 is for Health Retirement Account.

Details :

Heli - Arc Welding will be paid \$.30 above Journeyman rate. Additional compensation of 10% over the Journeyman Lineman and Journeyman Technician for performing work on structures outside of buildings such as water towers, smoke stacks, radio and television towers, more than 75' above the ground.

Prevailing Wage Rate Skilled Crafts

Name of Union: Electrical Local 71 Outside (North Central Ohio)

Change # : LCN01-2020fbLoc71CentralOhio

Craft : Lineman Effective Date : 11/04/2020 Last Posted : 11/04/2020

	BHR	Fringe Benefit Payments						Irrevocable Fund		Total PWR	Overtime Rate
		H&W	Pension	App Tr.	Vac.	Annuity	Other	LECET (*)	MISC (*)		
Classification											
Electrical Lineman	\$39.23	\$6.50	\$1.18	\$0.39	\$0.00	\$7.06	\$0.06	\$0.00	\$0.00	\$54.42	\$74.04
Traffic Signal & Lighting Journeyman	\$37.73	\$6.50	\$1.13	\$0.38	\$0.00	\$6.79	\$0.06	\$0.00	\$0.00	\$52.59	\$71.45
Equipment Operator	\$34.46	\$6.50	\$1.03	\$0.34	\$0.00	\$6.20	\$0.06	\$0.00	\$0.00	\$48.59	\$65.82
Groundman 0-12 months (W/O CDL)	\$20.90	\$6.50	\$0.63	\$0.21	\$0.00	\$3.76	\$0.06	\$0.00	\$0.00	\$32.06	\$42.51
Groundman 0-12 months (W/CDL) plus	\$22.83	\$6.50	\$0.68	\$0.23	\$0.00	\$4.11	\$0.06	\$0.00	\$0.00	\$34.41	\$45.82
Groundsman greater than 1 Year (W/CDL)	\$24.77	\$6.50	\$0.74	\$0.25	\$0.00	\$4.46	\$0.06	\$0.00	\$0.00	\$36.78	\$49.17
Traffic Signal Apprentices											
1st 1,000 hours	\$22.64	\$6.50	\$0.68	\$0.23	\$0.00	\$4.08	\$0.06	\$0.00	\$0.00	\$34.19	\$45.51
2nd 1,000 hours	\$24.52	\$6.50	\$0.74	\$0.25	\$0.00	\$4.41	\$0.06	\$0.00	\$0.00	\$36.48	\$48.74
3rd 1,000 hours	\$26.41	\$6.50	\$0.79	\$0.26	\$0.00	\$4.75	\$0.06	\$0.00	\$0.00	\$38.77	\$51.98
4th 1,000 hours	\$28.30	\$6.50	\$0.85	\$0.28	\$0.00	\$5.09	\$0.06	\$0.00	\$0.00	\$41.08	\$55.23
5th 1,000 hours	\$30.18	\$6.50	\$0.91	\$0.30	\$0.00	\$5.43	\$0.06	\$0.00	\$0.00	\$43.38	\$58.47
6th 1,000 hours	\$33.96	\$6.50	\$1.02	\$0.34	\$0.00	\$6.11	\$0.06	\$0.00	\$0.00	\$47.99	\$64.97

Apprentice Lineman	Percent											
1st 1,000 Hours	60.00	\$23.54	\$6.50	\$0.71	\$0.24	\$0.00	\$4.24	\$0.06	\$0.00	\$0.00	\$35.29	\$47.06
2nd 1,000 Hours	65.00	\$25.50	\$6.50	\$0.77	\$0.26	\$0.00	\$4.59	\$0.06	\$0.00	\$0.00	\$37.68	\$50.43
3rd 1,000 Hours	70.00	\$27.46	\$6.50	\$0.82	\$0.27	\$0.00	\$4.94	\$0.06	\$0.00	\$0.00	\$40.05	\$53.78
4th 1,000 Hours	75.00	\$29.42	\$6.50	\$0.88	\$0.29	\$0.00	\$5.30	\$0.06	\$0.00	\$0.00	\$42.45	\$57.16
5th 1,000 Hours	80.00	\$31.38	\$6.50	\$0.94	\$0.31	\$0.00	\$5.65	\$0.06	\$0.00	\$0.00	\$44.84	\$60.54
6th 1,000 Hours	85.00	\$33.35	\$6.50	\$1.00	\$0.33	\$0.00	\$6.00	\$0.06	\$0.00	\$0.00	\$47.24	\$63.91
7th 1,000 Hours	90.00	\$35.31	\$6.50	\$1.06	\$0.35	\$0.00	\$6.36	\$0.06	\$0.00	\$0.00	\$49.64	\$67.29

Special Calculation Note : Other is Safety & Education Fund.

Ratio :

1 Journeymen to 1 Apprentice

Jurisdiction (* denotes special jurisdictional note) :

BELMONT, CARROLL, HARRISON, HOLMES, JEFFERSON, MEDINA, PORTAGE, STARK, SUMMIT, WAYNE

Special Jurisdictional Note :

Details :

A groundman when directed shall assist a Journeyman in the performance of his/her work on the ground, including the use of hand tools. A Groundman under no circumstances shall climb poles, towers, ladders, or work from an elevated platform or bucket truck.

No more than three (3) Groundmen shall work alone. Jobs with more than three Groundmen shall be supervised by a Groundcrew Foreman, Journeyman Lineman, Journeyman Traffic Signal Technician or an Equipment Operator.

Scope of Work: installation and maintenance of highway and street lighting, highway and street sign lighting, electronic message boards and traffic control systems, camera systems, traffic signal work, substation and line construction including overhead and underground projects for private and industrial work as in accordance with the IBEW Constitution. This Agreement includes the operation of all tools and equipment necessary for the installation of the above projects.

Prevailing Wage Rate Skilled Crafts

Name of Union: Electrical Local 306 Lightning Rod

Change # : LCN01-2020fbLoc306VDV

Craft : Voice Data Video Effective Date : 06/29/2020 Last Posted : 06/25/2020

	BHR		Fringe Benefit Payments					Irrevocable Fund		Total PWR	Overtime Rate	
			H&W	Pension	App Tr.	Vac.	Annuity	Other	LECET (*)			MISC (*)
Classification												
Electrical Lightning Protection Installer	\$30.44		\$7.50	\$0.91	\$0.00	\$2.84	\$1.83	\$0.00	\$0.00	\$0.00	\$43.52	\$58.74
Apprentice	Percent											
1st Day- 6 months	50.00	\$15.22	\$7.50	\$0.46	\$0.00	\$0.00	\$0.92	\$0.41	\$0.00	\$0.00	\$24.51	\$32.12
2nd 6 months	55.00	\$16.74	\$7.50	\$0.50	\$0.00	\$0.00	\$1.01	\$0.45	\$0.00	\$0.00	\$26.20	\$34.57
3rd 6 months	60.00	\$18.26	\$7.50	\$0.55	\$0.00	\$0.89	\$1.10	\$0.00	\$0.00	\$0.00	\$28.30	\$37.44
4th 6 months	65.00	\$19.79	\$7.50	\$0.59	\$0.00	\$0.97	\$1.19	\$0.00	\$0.00	\$0.00	\$30.04	\$39.93
3rd Year	70.00	\$21.31	\$7.50	\$0.64	\$0.00	\$1.52	\$1.28	\$0.00	\$0.00	\$0.00	\$32.25	\$42.90
4th Year	80.00	\$24.35	\$7.50	\$0.73	\$0.00	\$1.73	\$1.46	\$0.00	\$0.00	\$0.00	\$35.77	\$47.95
5th Year	90.00	\$27.40	\$7.50	\$0.82	\$0.00	\$1.95	\$1.65	\$0.00	\$0.00	\$0.00	\$39.32	\$53.01

Special Calculation Note : Other is Holiday

Ratio :
Journeyman to 1 Apprentice

Jurisdiction (* denotes special jurisdictional note)
MEDINA*, PORTAGE*, SUMMIT, WAYNE*

Special Jurisdictional Note : In Medina County the following townships are included: (Brunswick, Chatham, Franconia, Guilford, Harrisville, Hinckley, Homer, Lafayette, Medina, Montville, Sharon, Spencer, Wadsworth, Vestfield and York). In Portage County the following townships are included: (Atwater, Aurora, Brimfield, Deerfield, Franklin, Mantua, Randolph, Ravenna, Rootstown, Shalersville, Streetsboro and Suffield). In Wayne County the following townships are included: (Baughman, Canaan, Chester, Chippewa, Congress, Green, Hilton, and Wayne).

Details :

Prevailing Wage Rate

Skilled Crafts

Name of Union: Glazier Local 181

Change # : LCN01-2020fbLoc181

Draft : Glazier Effective Date : 07/02/2020 Last Posted : 07/02/2020

	BHR		Fringe Benefit Payments						Irrevocable Fund		Total PWR	Overtime Rate
			H&W	Pension	App Tr.	Vac.	Annuity	Other	LECET (*)	MISC (*)		
Classification												
Glazier	\$32.82		\$7.17	\$10.33	\$0.40	\$0.00	\$0.00	\$0.00	\$0.00	\$0.00	\$50.72	\$67.13
Apprentice	Percent											
1st 6 months	40.00	\$13.13	\$7.17	\$0.92	\$0.40	\$0.00	\$0.00	\$0.00	\$0.00	\$0.00	\$21.62	\$28.18
2nd 6 months	45.00	\$14.77	\$7.17	\$0.92	\$0.40	\$0.00	\$0.00	\$0.00	\$0.00	\$0.00	\$23.26	\$30.64
3rd 6 months	50.00	\$16.41	\$7.17	\$4.71	\$0.40	\$0.00	\$0.00	\$0.00	\$0.00	\$0.00	\$28.69	\$36.90
4th 6 months	55.00	\$18.05	\$7.17	\$5.08	\$0.40	\$0.00	\$0.00	\$0.00	\$0.00	\$0.00	\$30.70	\$39.73
5th 6 months	60.00	\$19.69	\$7.17	\$5.46	\$0.40	\$0.00	\$0.00	\$0.00	\$0.00	\$0.00	\$32.72	\$42.57
6th 6 months	70.00	\$22.97	\$7.17	\$6.22	\$0.40	\$0.00	\$0.00	\$0.00	\$0.00	\$0.00	\$36.76	\$48.25
7th 6 months	80.00	\$26.26	\$7.17	\$6.98	\$0.40	\$0.00	\$0.00	\$0.00	\$0.00	\$0.00	\$40.81	\$53.93
8th 6 months	90.00	\$29.54	\$7.17	\$7.73	\$0.40	\$0.00	\$0.00	\$0.00	\$0.00	\$0.00	\$44.84	\$59.61

Special Calculation Note : No special calculations for this classification.

Ratio :

Journeymen to 1 Apprentice
 Journeymen to 1 Apprentice Thereafter

Jurisdiction (* denotes special jurisdictional note)

ASHTABULA, CUYAHOGA, ERIE*, GEAUGA, HURON,
 LAKE, LORAIN, MEDINA*, PORTAGE*, SUMMIT*

Special Jurisdictional Note : Start at the intersection of Route 305 and the eastern boundary line of Portage County. Follow Route 305 west onto Route 82, follow Route 82 west to the intersection of Routes 82,8 and 271, follow Route 271 south to Medina County line west to Route 94, follow Route 94 south to Route 303, follow Route 303 west to Route 252, follow Route 252 south to Route 18, follow Route 18 west to Route 301, follow Route 301 south to Route 162, follow Route 162 west to Route 58, follow Route 58 south to the Ashland County line, follow the Ashland County line. The eastern part of Route 4 north to Lake Erie is the jurisdiction of Local 181. Local 181 has the jurisdiction on all projects built on the property which borders on the above Routes and/or intersections, wherever a County line is the divider between Local 181 and another Union, the jurisdiction is only to the county line.

Details :

High Pay: All work is defined for the purpose of the agreement as being work which requires that the employee be supported by equipment that hangs from or suspends from the wall or roof of a building or structure. This work shall receive an additional \$1.25 per hour.

Prevailing Wage Rate Skilled Crafts

Name of Union: Glazier Local 1162

Change # : LCN02-2020fbLoc1162

Craft : Glazier Effective Date : 05/14/2020 Last Posted : 05/14/2020

	BHR		Fringe Benefit Payments					Irrevocable Fund		Total PWR	Overtime Rate	
			H&W	Pension	App Tr.	Vac.	Annuity	Other	LECET (*)			MISC (*)
Classification												
Glazier	\$27.02		\$6.78	\$6.64	\$0.35	\$0.00	\$0.00	\$0.00	\$0.00	\$0.00	\$40.79	\$54.30
Apprentice	Percent											
1st 6 months	50.00	\$13.51	\$6.78	\$6.64	\$0.35	\$0.00	\$0.00	\$0.00	\$0.00	\$0.00	\$27.28	\$34.04
2nd 6 months	55.00	\$14.86	\$6.78	\$6.64	\$0.35	\$0.00	\$0.00	\$0.00	\$0.00	\$0.00	\$28.63	\$36.06
3rd 6 months	60.00	\$16.21	\$6.78	\$6.64	\$0.35	\$0.00	\$0.00	\$0.00	\$0.00	\$0.00	\$29.98	\$38.09
4th 6 months	65.00	\$17.56	\$6.78	\$6.64	\$0.35	\$0.00	\$0.00	\$0.00	\$0.00	\$0.00	\$31.33	\$40.11
5th 6 months	70.00	\$18.91	\$6.78	\$6.64	\$0.35	\$0.00	\$0.00	\$0.00	\$0.00	\$0.00	\$32.68	\$42.14
6th 6 months	75.00	\$20.26	\$6.78	\$6.64	\$0.35	\$0.00	\$0.00	\$0.00	\$0.00	\$0.00	\$34.04	\$44.17
7th 6 months	80.00	\$21.62	\$6.78	\$6.64	\$0.35	\$0.00	\$0.00	\$0.00	\$0.00	\$0.00	\$35.39	\$46.19
8th 6 months	90.00	\$24.32	\$6.78	\$6.64	\$0.35	\$0.00	\$0.00	\$0.00	\$0.00	\$0.00	\$38.09	\$50.25

Special Calculation Note :

Ratio :

1 Journeyman to 1 Apprentice
2 Journeyman to 1 Apprentice

Jurisdiction (* denotes special jurisdictional note) :

ASHLAND, CARROLL, COSHOCTON, HOLMES, MEDINA, PORTAGE, RICHLAND, STARK, SUMMIT, TUSCARAWAS, WAYNE

Special Jurisdictional Note :

Details :

Add \$1.25 per hour for High Pay which is all work that requires the employee be supported by equipment which hangs or suspends from the roof of a building or structure including all repelling .

Prevailing Wage Rate Skilled Crafts

Name of Union: Ironworker Local 17

Change # : LCN01-2020fbLoc17

Craft : Ironworker Effective Date : 12/24/2020 Last Posted : 12/24/2020

	BHR		Fringe Benefit Payments					Irrevocable Fund		Total PWR	Overtime Rate	
			H&W	Pension	App Tr.	Vac.	Annuity	Other	LECET (*)			MISC (*)
Classification												
Ironworker	\$33.83		\$7.94	\$10.00	\$0.67	\$2.10	\$4.50	\$0.00	\$0.00	\$0.00	\$59.04	\$75.95
Apprentice	Percent											
1st 6 Months	50.00	\$16.91	\$7.94	\$10.00	\$0.67	\$2.10	\$4.50	\$0.00	\$0.00	\$0.00	\$42.13	\$50.58
2nd 6 Months	55.00	\$18.61	\$7.94	\$10.00	\$0.67	\$2.10	\$4.50	\$0.00	\$0.00	\$0.00	\$43.82	\$53.12
2nd Year 1st 6 Months	70.00	\$23.68	\$7.94	\$10.00	\$0.67	\$2.10	\$4.50	\$0.00	\$0.00	\$0.00	\$48.89	\$60.73
2nd Year 2nd 6 Months	75.00	\$25.37	\$7.94	\$10.00	\$0.67	\$2.10	\$4.50	\$0.00	\$0.00	\$0.00	\$50.58	\$63.27
3rd Year 1st 6 Months	80.00	\$27.06	\$7.94	\$10.00	\$0.67	\$2.10	\$4.50	\$0.00	\$0.00	\$0.00	\$52.27	\$65.81
3rd Year 2nd 6 Months	85.00	\$28.76	\$7.94	\$10.00	\$0.67	\$2.10	\$4.50	\$0.00	\$0.00	\$0.00	\$53.97	\$68.34
4th Year 1st 6 Months	90.00	\$30.45	\$7.94	\$10.00	\$0.67	\$2.10	\$4.50	\$0.00	\$0.00	\$0.00	\$55.66	\$70.88
4th Year 2nd 6 Months	95.00	\$32.14	\$7.94	\$10.00	\$0.67	\$2.10	\$4.50	\$0.00	\$0.00	\$0.00	\$57.35	\$73.42

Special Calculation Note : No special calculations for this skilled craft wage rate are required at this time.

Ratio :

4 Journeymen to 1 Apprentice on Structural Work
 3 Journeymen to 1 Apprentice on Rod Work
 2 Journeymen to 1 Apprentice on Finishing, Steel Sash, Stairway and Ornamental Work

Jurisdiction (* denotes special jurisdictional note) :

ASHTABULA, CUYAHOGA, ERIE, GEAUGA, HURON, LAKE, LORAIN, MEDINA, PORTAGE, SUMMIT

1 Apprentice for every Sheeting Gang
1 Journeymen to 2 Apprentice Roadway Signage and
Sound Barriers
2 Journeymen to 2 Apprentice Unloading and
Erection of Light Gauge Metal Trusses

Special Jurisdictional Note : West Boundary Line :Sandusky, Ohio: Boundary lines between Local 17 & Local 55 are as follows: Columbus Ave north to Sandusky Bay (and/or Lake Erie): Columbus Ave South to present Route 4: Route 4 South to present Route 99: from Route 99 south to old Route 224-all territory to the west of the boundary line to be the jurisdiction of Local 55.All territory to the East of the boundary line to be the jurisdiction of Local 17.Kelly's Island to be within jurisdiction of Local 17.All bridges,tunnels,viaducts,etc, relative to these boundary lines shall be the jurisdiction of Local 17

South Boundary Line:Canton, Ohio: Boundary lines between Local 17 & Local 550 are as follows: All territory north of old Route 224 line to be the jurisdiction of Local 17. All bridges,tunnels,viaducts,signs,etc, relative to old Route 224 line to be within the jurisdiction of Local 17. All territory south of old Route 224 line is to be within the jurisdiction of Local 550, except for everything within the city limits of Barberton which shall be the jurisdiction of Local 17. Reading from West to East: Route old 224 line: Greenwich Ave-Wooster Road or East Ave. Route old 224 line: New 224 line including Cloverleaf: East Waterloo Road: New 224 line-Attwood Road-Old 224. This will be considered to be the old Route 224 line,except for the city limits of Barberton, Ohio which shall be the jurisdiction of Local 17

Southeast Boundary : Between local 17 and Local 207 are as follows: West of a line from Middlefield to Shalersville to Deerfield, shall be under the jurisdiction of local 17. East of a line from Middlefield, to Shalersville to Deerfield, shall be under the jurisdiction of Local 207.

Local 17 & Local 207 have agreed that the Ohio County of Ashtabula shall be as follows: Everything North of Route 6, starting at the Geauga County line, proceeding east to State Route 45, shall be under the jurisdiction of Local 17. Everything South, starting at the Geauga County line shall be under local 207.

North Boundary: The East boundary line and the West boundary line continuing North halfway across Lake Erie.

Details :

Prevailing Wage Rate Skilled Crafts

Name of Union: Ironworker Local 550

Change # : LCR01-2020fbLoc550

Craft : Ironworker Effective Date : 05/01/2020 Last Posted : 03/17/2020

	BHR		Fringe Benefit Payments					Irrevocable Fund		Total PWR	Overtime Rate	
			H&W	Pension	App Tr.	Vac.	Annuity	Other	LECET (*)			MISC (*)
Classification												
Ironworker	\$29.27		\$8.18	\$9.02	\$0.74	\$0.00	\$2.73	\$0.41	\$0.00	\$0.00	\$50.35	\$64.98
Apprentice	Percent											
1st 6 months	60.00	\$17.56	\$8.18	\$9.02	\$0.74	\$0.00	\$2.73	\$0.41	\$0.00	\$0.00	\$38.64	\$47.42
2nd 6 months	65.00	\$19.03	\$8.18	\$9.02	\$0.74	\$0.00	\$2.73	\$0.41	\$0.00	\$0.00	\$40.11	\$49.62
3rd 6 months	70.00	\$20.49	\$8.18	\$9.02	\$0.74	\$0.00	\$2.73	\$0.41	\$0.00	\$0.00	\$41.57	\$51.81
4th 6 months	75.00	\$21.95	\$8.18	\$9.02	\$0.74	\$0.00	\$2.73	\$0.41	\$0.00	\$0.00	\$43.03	\$54.01
5th 6 months	80.00	\$23.42	\$8.18	\$9.02	\$0.74	\$0.00	\$2.73	\$0.41	\$0.00	\$0.00	\$44.50	\$56.20
6th 6 months	85.00	\$24.88	\$8.18	\$9.02	\$0.74	\$0.00	\$2.73	\$0.41	\$0.00	\$0.00	\$45.96	\$58.40
7th 6 months	90.00	\$26.34	\$8.18	\$9.02	\$0.74	\$0.00	\$2.73	\$0.41	\$0.00	\$0.00	\$47.42	\$60.59
8th 6 months	95.00	\$27.81	\$8.18	\$9.02	\$0.74	\$0.00	\$2.73	\$0.41	\$0.00	\$0.00	\$48.89	\$62.79

Special Calculation Note : OTHER IS: JOURNEYMAN UPGRADE AND WELLNESS FUND.

Ratio :

- 4 Journeymen to 1 Apprentice
- 1 Journeymen to 1 Apprentice, spinning of cable for suspension bridge
- 1 Journeymen to 1 Apprentice, ornamental work
- 2 Journeymen to 1 Apprentice, reinforcing work
- 1 Journeymen to 2 Apprentice, roadway

Jurisdiction (* denotes special jurisdictional note) :

- ASHLAND, CARROLL, COLUMBIANA*,
- COSHOCTON, HOLMES*, HURON, MAHONING*,
- MEDINA*, PORTAGE*, RICHLAND, STARK,
- SUMMIT*, TUSCARAWAS, WAYNE

Special Jurisdictional Note : The jurisdictional line between Local 17 and Local 550 is determined as follows: All territory North of Old Route 224 line to be within the jurisdiction of Local 17. All territory South of Old Route 224 line is to be the jurisdiction of Local 550, except for everything within the City limits of Barberton which shall be under the jurisdiction of Local 17.

Details :

Prevailing Wage Rate Skilled Crafts

Name of Union: Labor HevHwy 2

Change # : LCN01-2020fbLaborHevHwy2

Craft : Laborer Group 1 Effective Date : 05/14/2020 Last Posted : 05/14/2020

	BHR		Fringe Benefit Payments					Irrevocable Fund		Total PWR	Overtime Rate	
			H&W	Pension	App Tr.	Vac.	Annuity	Other	LECET (*)			MISC (*)
Classification												
Laborer Group 1	\$33.05		\$7.00	\$3.80	\$0.45	\$0.00	\$0.00	\$0.00	\$0.10	\$0.00	\$44.40	\$60.92
Group 2	\$33.22		\$7.00	\$3.80	\$0.45	\$0.00	\$0.00	\$0.00	\$0.10	\$0.00	\$44.57	\$61.18
Group 3	\$33.55		\$7.00	\$3.80	\$0.45	\$0.00	\$0.00	\$0.00	\$0.10	\$0.00	\$44.90	\$61.67
Group 4	\$34.00		\$7.00	\$3.80	\$0.45	\$0.00	\$0.00	\$0.00	\$0.10	\$0.00	\$45.35	\$62.35
Watch Person	\$25.35		\$7.00	\$3.80	\$0.45	\$0.00	\$0.00	\$0.00	\$0.10	\$0.00	\$36.70	\$49.38
Apprentice	Percent											
0-1000 hrs	60.00	\$19.83	\$7.00	\$3.80	\$0.45	\$0.00	\$0.00	\$0.00	\$0.10	\$0.00	\$31.18	\$41.10
1001-2000 hrs	70.02	\$23.14	\$7.00	\$3.80	\$0.45	\$0.00	\$0.00	\$0.00	\$0.10	\$0.00	\$34.49	\$46.06
2001-3000 hrs	80.00	\$26.44	\$7.00	\$3.80	\$0.45	\$0.00	\$0.00	\$0.00	\$0.10	\$0.00	\$37.79	\$51.01
3001-4000 hrs	90.00	\$29.74	\$7.00	\$3.80	\$0.45	\$0.00	\$0.00	\$0.00	\$0.10	\$0.00	\$41.10	\$55.97
More Than 4000 hrs	100.00	\$33.05	\$7.00	\$3.80	\$0.45	\$0.00	\$0.00	\$0.00	\$0.10	\$0.00	\$44.40	\$60.92

Special Calculation Note : Watchman has no Apprentices. Tunnel Laborer rate with air-pressurized add \$1.00 to the above wage rate.

Ratio :

1 Journeymen to 1 Apprentice
3 Journeymen to 1 Apprentice thereafter

Jurisdiction (* denotes special jurisdictional note) :

ASHTABULA, ERIE, HURON, LORAIN, LUCAS, MAHONING, MEDINA, OTTAWA, PORTAGE, SANDUSKY, STARK, SUMMIT, TRUMBULL, WOOD

Special Jurisdictional Note : Hod Carriers and Common Laborers - Heavy, Highway, Sewer, Waterworks, Utility, Airport, Railroad, Industrial and Building Site, Sewer Plant, Waste Water Treatment Facilities Construction

Details :

Group 1

Laborer (Construction); Plant Laborer or Yardman, Right-of-way Laborer, Landscape Laborer, Highway Lighting Worker, Signalization Worker, (Swimming) Pool Construction Laborer, Utility Man, *Bridge Man, Handyman, Joint Setter, Flagperson, Carpenter Helper, Waterproofing Laborer, Slurry Seal, Seal Coating, Surface Treatment or Road Mix Laborer, Riprap Laborer & Grouter, Asphalt Laborer, Dump Man (batch trucks), Guardrail & Fence Installer, Mesh Handler & Placer, Concrete Curing Applicator, Scaffold Erector, Sign Installer, Hazardous Waste (level D), Diver Helper, Zone Person and Traffic Control.

*Bridge Man will perform work as per the October 31, 1949, memorandum on concrete forms, by and between the United Brotherhood of Carpenters and Joiners of America and the Laborers' International Union of North America, which states in; "the moving, cleaning, oiling and carrying to the next point of erection, and the stripping of forms which are not to be re-used, and forms on all flat arch work shall be done by members of the Laborers' International Union of North America."

Group 2

Asphalt Raker, Screwman or Paver, Concrete Puddler, Kettle Man (pipeline), All Machine-Driven Tools (Gas, Electric, Air), Mason Tender, Brick Paver, Mortar Mixer, Skid Steer, Sheeting & Shoring Person, Surface Grinder Person, Screedperson, Water Blast, Hand Held Wand, Power Buggy or Power Wheelbarrow, Paint Striper, Plastic fusing Machine Operator, Rodding Machine Operator, Pug Mill Operator, Operator of All Vacuum Devices Wet or Dry, Handling of all Pumps 4 inches and under (gas, air or electric), Diver, Form Setter, Bottom Person, Welder Helper (pipeline), Concrete Saw Person, Cutting with Burning Torch, Pipe Layer, Hand Spiker (railroad), Underground Person (working in sewer and waterline, cleaning, repairing and reconditioning). Tunnel Laborer (without air), Caisson, Cofferdam (below 25 feet deep), Air Track and Wagon Drill, Sandblaster Nozzle Person, Hazardous Waste (level B), ***Lead Abatement, Hazardous Waste (level C)

***Includes the erecting of structures for the removal, including the encapsulation and containment of Lead abatement process.

Group 3

Blast and Powder Person, Muckers will be defined as shovel men working directly with the miners, Wrencher (mechanical joints & utility pipeline), Yarnier, Top Lander, Hazardous Waste (level A), Concrete Specialist, Curb Setter and Cutter, Grade Checker, Concrete Crew in Tunnels. Utility pipeline Tappers, Waterline, Caulker, Signal Person will receive the rate equal to the rate paid the Laborer classification for which the Laborer is signaling.

Group 4

Miner, Welder, Gunite Nozzle Person

A.) The Watchperson shall be responsible to patrol and maintain a safe traffic zone including but not limited to barrels, cones, signs, arrow boards, message boards etc.

The responsibility of a watchperson is to see that the equipment, job and office trailer etc. are secure.

Prevailing Wage Rate Skilled Crafts

Name of Union: Labor Local 894 Building

Change # : LCN01-2021fbLoc894

Craft : Laborer Effective Date : 01/12/2021 Last Posted : 01/12/2021

	BHR		Fringe Benefit Payments					Irrevocable Fund		Total PWR	Overtime Rate	
			H&W	Pension	App Tr.	Vac.	Annuity	Other	LECET (*)			MISC (*)
Classification												
Laborer Group 1	\$32.92		\$7.00	\$3.80	\$0.40	\$0.00	\$0.00	\$0.00	\$0.10	\$0.00	\$44.22	\$60.68
Laborer Group 2	\$33.07		\$7.00	\$3.80	\$0.40	\$0.00	\$0.00	\$0.00	\$0.10	\$0.00	\$44.37	\$60.91
Laborer Group 3	\$33.12		\$7.00	\$3.80	\$0.40	\$0.00	\$0.00	\$0.00	\$0.10	\$0.00	\$44.42	\$60.98
Laborer Group 4	\$33.42		\$7.00	\$3.80	\$0.40	\$0.00	\$0.00	\$0.00	\$0.10	\$0.00	\$44.72	\$61.43
Laborer Group 5	\$27.95		\$7.00	\$3.80	\$0.40	\$0.00	\$0.00	\$0.00	\$0.10	\$0.00	\$39.25	\$53.22
Apprentice	Percent											
1ST 1-1000 hrs	60.00	\$19.75	\$7.00	\$3.80	\$0.40	\$0.00	\$0.00	\$0.00	\$0.10	\$0.00	\$31.05	\$40.93
2nd 1000-2000 hrs	70.00	\$23.04	\$7.00	\$3.80	\$0.40	\$0.00	\$0.00	\$0.00	\$0.10	\$0.00	\$34.34	\$45.87
3rd 2000-3000 hrs	80.00	\$26.34	\$7.00	\$3.80	\$0.40	\$0.00	\$0.00	\$0.00	\$0.10	\$0.00	\$37.64	\$50.80
4th 3000-4000 hrs	90.00	\$29.63	\$7.00	\$3.80	\$0.40	\$0.00	\$0.00	\$0.00	\$0.10	\$0.00	\$40.93	\$55.74
More than 4000 hrs	100.00	\$32.92	\$7.00	\$3.80	\$0.40	\$0.00	\$0.00	\$0.00	\$0.10	\$0.00	\$44.22	\$60.68

Special Calculation Note : \$0.10 for LECET is for Labor Management

Ratio :

1 Apprentice to 1 Journeymen
1 Apprentice to 4 Journeymen

Jurisdiction (* denotes special jurisdictional note) :

MEDINA, PORTAGE, SUMMIT

Special Jurisdictional Note :

Details :

Group 1

Building & Construction Laborer, Welder Helper, Carpenter Tender, Landscape Laborer, Mason Tender, Concrete Bucket Tender, Concrete & Construction Specialist, Asbestos Laborer, Toxic/Hazardous Waste Laborer, Lead Removal, Level D

Group 2

Air Driven Boring Machine, Tamper Operator, Asphalt Raker, Paving Bed Maker, Concrete Puddler on Building Work, Concrete Batch Dumper, Materials Mixer, Wire Mesh Handler, Hook-up on Demolition Work, Scaffold Erector, Structural, Precast Erector, Power Tools - Air, Gas or Electric, Hazardous Waste Laborer, Lead Removal Level C

Group 3

Pipe Layer, Rock Driller, Mucker-Tunnel, Burner, Form Setter, Power Saw Jackhammer, Bottom Man, Hod Carrier, Power Buggy or Power Wheelbarrow, Bob Cat, Skid Steer Work and or similar, Hazardous Waste Laborer, Lead Removal Level B

Group 4

Gunnite Nozzle Man, Tunnel Miner, Water Link Caulker, Dynamite Man, Structural Precast Welder, Pump Hose Nozzle Man, Hazardous Waste Laborer, Lead Removal Level A

Group 5

Watchman

Hazardous Waste Removal and Lead Abatement:

For Laborers, working in an exclusive or "hot" area with toxic or hazardous materials, one of the following personal protective equipment ensembles will be required.

Level A

When the area has been determined to contain extremely toxic contaminants or contaminants unknown but may be expected to be extremely toxic and/or immediately dangerous to life and health. This ensemble includes a fully encapsulated chemical suit, self contained breathing apparatus (SCBA) or airline fed respirator, and various types and numbers of boots and gloves; cool vests and voice-activated radios are optional equipment sometimes worn.

Level B

Protective equipment includes a chemically resistant splash suit and a SCBA or airline respirator. This ensemble is required when the situation is very hazardous, such as oxygen deficient atmospheres, IDLH atmospheres, or confined space entries, but the risk of skin exposure is not as great as in Level A situation.

Level C

Protective equipment includes a protective suit and an air purifying respirator (APR) with the appropriate filter canisters. The ensemble is used when the contaminants are reliably known not to be hazardous to the skin and not IDLH (Immediately Dangerous to Life or Health) and correct filter protection is available.

Level D

Protective Equipment to be worn only in established "safe zones" may consist of, from normal work clothes to normal skin protection such as gloves, face shields goggles, coveralls and occasionally respiratory protection.

Prevailing Wage Rate Skilled Crafts

Name of Union: Operating Engineers - Building Local 18 - Zone I

Change # : LCN01-2020fbLoc18

Craft : Operating Engineer Effective Date : 05/14/2020 Last Posted : 05/14/2020

	BHR		Fringe Benefit Payments					Irrevocable Fund		Total PWR	Overtime Rate	
			H&W	Pension	App Tr.	Vac.	Annuity	Other	LECET (*)			MISC (*)
Classification												
Operator Class 1	\$39.73		\$8.51	\$6.00	\$0.85	\$0.00	\$0.00	\$0.09	\$0.00	\$0.00	\$55.18	\$75.04
Class 2	\$39.63		\$8.51	\$6.00	\$0.85	\$0.00	\$0.00	\$0.09	\$0.00	\$0.00	\$55.08	\$74.90
Class 3	\$38.59		\$8.51	\$6.00	\$0.85	\$0.00	\$0.00	\$0.09	\$0.00	\$0.00	\$54.04	\$73.34
Class 4	\$37.37		\$8.51	\$6.00	\$0.85	\$0.00	\$0.00	\$0.09	\$0.00	\$0.00	\$52.82	\$71.50
Class 5	\$32.08		\$8.51	\$6.00	\$0.85	\$0.00	\$0.00	\$0.09	\$0.00	\$0.00	\$47.53	\$63.57
Class 6	\$39.98		\$8.51	\$6.00	\$0.85	\$0.00	\$0.00	\$0.09	\$0.00	\$0.00	\$55.43	\$75.42
Class 7	\$40.23		\$8.51	\$6.00	\$0.85	\$0.00	\$0.00	\$0.09	\$0.00	\$0.00	\$55.68	\$75.79
Class 8	\$40.73		\$8.51	\$6.00	\$0.85	\$0.00	\$0.00	\$0.09	\$0.00	\$0.00	\$56.18	\$76.54
Class 9	\$40.98		\$8.51	\$6.00	\$0.85	\$0.00	\$0.00	\$0.09	\$0.00	\$0.00	\$56.43	\$76.92
Apprentice	Percent											
1st Year	50.00	\$19.86	\$8.51	\$6.00	\$0.85	\$0.00	\$0.00	\$0.09	\$0.00	\$0.00	\$35.32	\$45.25
2nd Year	60.00	\$23.84	\$8.51	\$6.00	\$0.85	\$0.00	\$0.00	\$0.09	\$0.00	\$0.00	\$39.29	\$51.21
3rd Year	70.00	\$27.81	\$8.51	\$6.00	\$0.85	\$0.00	\$0.00	\$0.09	\$0.00	\$0.00	\$43.26	\$57.17
4th Year	80.00	\$31.78	\$8.51	\$6.00	\$0.85	\$0.00	\$0.00	\$0.09	\$0.00	\$0.00	\$47.23	\$63.13
Field Mechanic Trainee												
1st Year	50.00	\$19.86	\$8.51	\$6.00	\$0.85	\$0.00	\$0.00	\$0.09	\$0.00	\$0.00	\$35.32	\$45.25
2nd Year	60.00	\$23.84	\$8.51	\$6.00	\$0.85	\$0.00	\$0.00	\$0.09	\$0.00	\$0.00	\$39.29	\$51.21
3rd Year	70.00	\$27.81	\$8.51	\$6.00	\$0.85	\$0.00	\$0.00	\$0.09	\$0.00	\$0.00	\$43.26	\$57.17
4th Year	80.00	\$31.78	\$8.51	\$6.00	\$0.85	\$0.00	\$0.00	\$0.09	\$0.00	\$0.00	\$47.23	\$63.13

Special Calculation Note : Other: Education & Safety Fund is \$0.09 per hour.

Ratio : **Jurisdiction (* denotes special jurisdictional note) :**

For every (3) Operating Engineer Journeymen employed by SUMMIT, PORTAGE the company, there may be employed (1) Registered Apprentice or Trainee Engineer through the referral when they are available. An apprentice, while employed as part of a crew per Article VIII, paragraph 77, will not be subject to the apprenticeship ratios in this collective bargaining

Special Jurisdictional Note :

Details :

Note: There will be a 10% increase for the apprentices on top of the percentages listed above provided they are operating mobile equipment. Mechanic Trainees will receive 10% increase if required to have CDL

Class 1 - Barrier Moving Machine; Boiler Operators or Compressor Operators, when compressor or boiler is mounted on crane (Piggyback Operation); Boom Trucks (all types); Cableways Cherry Pickers; Combination - Concrete Mixers & Towers; All Concrete Pumps with Booms; Cranes (all types) Derricks (all types); Draglines Dredges (dipper, clam or suction) 3-man crew; Elevating Graders or Euclid Loaders; Floating Equipment; Gradalls; Helicopter Operators; hoisting building materials; Helicopter Winch Operators, Hoisting building materials; Hoes (All types) Hoists (with two or more drums in use); Hydraulic Gantry (lift system); Laser Finishing Machines; Lift Slab or Panel Jack Operators; Locomotives (all types); Maintenance Engineers (Mechanic and/or Welder); Mixers, paving (multiple drum); Mobile Concrete Pumps, with booms, Panelboards, (all types on site); Pile Drivers; Power Shovels; Prentice Loader; Rail Tamper (with automatic lifting and aligning device); Rotary Drills (all), used on caissons for foundations and sub-structure work; Side Booms; Slip Form Pavers; Straddle Carriers (Building Construction on site); Tug Boats. Horizontal Directional Drill, Rough Terrain Fork-lift with Winch/Hoist, Laser Screed, and Like equipment, Compact Cranes, track or rubber over 4,000 pound capacity, self-erecting cranes: stationary, track or truck (all configurations) bucket trench machines (over 24 " wide).

Class 2 - Asphalt Pavers; Bobcat-type and/or skid steer loader with hoe attachment greater than 7000 lbs.; Bulldozers; CMI type Equipment; C; Endloaders; Hydro Milling Machine; Kolman-type Loaders (Dirt Loading); Lead Greasemen; Mucking Machines; Pettibone-Rail Equipment; Power Graders; Power Scoops; Power Scrapers; Push Cats; Vermeer Type Concrete Saw, All rotomills, grinders & planers of all types. Articulating/end dumps (minus \$4.00/hour from Class 2 rate)

Class 3 - A Frames; Air Compressors, Pressurizing Shafts or Tunnels; All Asphalt Rollers; Bobcat-type and/or skid steer loader with or without attachments; Boilers (15 lbs pressure and over); All concrete Pumps (without booms with 5 inch system); Fork Lifts (except masonry); Highway Drillers - all types (with integral power); Hoists (with one drum); House Elevators (except those automatic call button controlled); Man Lifts; Mud Jacks; Pressure Grouting; Pump Operators (installing or operating Well Points or other types of Dewatering Systems); Pumps (4 inches and over discharge); Railroad Tie Inserter/Remover; Rotator (Lime-Soil Stabilizer); Submersible Pumps (4 inches and over discharge); Switch & Tie Tampers (without lifting and aligning device); Trench Machines (24 inches and under); Utility Operators, Material hoist/elevators.

Class 4 - Ballast Re-locator; Backfillers and Tampers; Batch Plant Operators; Bar and Joint Installing Machines; Bull Floats; Burlap and Curing Machines; Clefplanes; Compressors, on building construction; Concrete Spreader; Conveyors, used for handling building materials; Concrete Mixers, one bag capacity (side loader); Concrete Mixers, capacity more than one bag; Crushers; Deck Hands; Drum Fireman (in Asphalt Plant); Farm type tractors pulling attachments; Finishing Machines; Form Trenchers; Generators: Guniting Machines; Hydro-Seeders; Pavement Breakers (hydraulic or cable); Post Drivers; Post Hole Diggers; Pressure Pumps (over 1/2 inch discharge); Road Widening Trenchers; Rollers (except asphalt); All Concrete pumps (without Boom with 4 inch or smaller systems); self-propelled Power Spreaders; self-propelled Sub-graders; Shotcrete Machines; Tire Repairmen; Tractors, pulling sheepfoot rollers or graders; VAC/ALLS; Vibratory Compactors, with integral power; Welder Operators.

Class 5 - Boilers (less than 15 lbs. pressure); Inboard/outboard Motor Boat Launches; Light Plant Operators; Masonry Fork Lifts; Oilers/Helpers; Power Driven Heaters (oil fired); Power Scrubbers; Power Sweepers; Pumps (under 4 inch discharge); Signalmen, Submersible Pumps (under 4 inch discharge). Directional Drill Locator and Allen Screed Concrete Paver, Fueling & greasing (Primary Operator with Specialized CDL Endorsement Add \$3.00/ hour), compact cranes: track or rubber under 4,000 pounds.

Class 6 - Master Mechanic

Class 7 - Boom & Jib 150 - 180 feet

Class 8 - Boom & Jib 180 - 249 feet

Class 9 - Boom & Jib 250 - or over

Prevailing Wage Rate Skilled Crafts

Name of Union: Operating Engineers - HevHwy Zone I

Change # : LCN01-2020fbLoc18hevhwyl

Craft : Operating Engineer Effective Date : 05/14/2020 Last Posted : 05/14/2020

	BHR		Fringe Benefit Payments					Irrevocable Fund		Total PWR	Overtime Rate	
			H&W	Pension	App Tr.	Vac.	Annuity	Other	LECET (*)			MISC (*)
Classification												
Operator Class 1	\$39.73		\$8.51	\$6.00	\$0.85	\$0.00	\$0.00	\$0.09	\$0.00	\$0.00	\$55.18	\$75.04
Class 2	\$39.63		\$8.51	\$6.00	\$0.85	\$0.00	\$0.00	\$0.09	\$0.00	\$0.00	\$55.08	\$74.90
Class 3	\$38.59		\$8.51	\$6.00	\$0.85	\$0.00	\$0.00	\$0.09	\$0.00	\$0.00	\$54.04	\$73.34
Class 4	\$37.37		\$8.51	\$6.00	\$0.85	\$0.00	\$0.00	\$0.09	\$0.00	\$0.00	\$52.82	\$71.50
Class 5	\$32.08		\$8.51	\$6.00	\$0.85	\$0.00	\$0.00	\$0.09	\$0.00	\$0.00	\$47.53	\$63.57
Class 6	\$39.98		\$8.51	\$6.00	\$0.85	\$0.00	\$0.00	\$0.09	\$0.00	\$0.00	\$55.43	\$75.42
Apprentice	Percent											
1st Year	50.00	\$19.86	\$8.51	\$6.00	\$0.85	\$0.00	\$0.00	\$0.09	\$0.00	\$0.00	\$35.32	\$45.25
2nd Year	60.00	\$23.84	\$8.51	\$6.00	\$0.85	\$0.00	\$0.00	\$0.09	\$0.00	\$0.00	\$39.29	\$51.21
3rd Year	70.00	\$27.81	\$8.51	\$6.00	\$0.85	\$0.00	\$0.00	\$0.09	\$0.00	\$0.00	\$43.26	\$57.17
4th Year	80.00	\$31.78	\$8.51	\$6.00	\$0.85	\$0.00	\$0.00	\$0.09	\$0.00	\$0.00	\$47.23	\$63.13
Field Mech Trainee												
1st year	49.85	\$19.81	\$8.51	\$6.00	\$0.85	\$0.00	\$0.00	\$0.09	\$0.00	\$0.00	\$35.26	\$45.16
2nd year	59.85	\$23.78	\$8.51	\$6.00	\$0.85	\$0.00	\$0.00	\$0.09	\$0.00	\$0.00	\$39.23	\$51.12
3rd year	69.82	\$27.74	\$8.51	\$6.00	\$0.85	\$0.00	\$0.00	\$0.09	\$0.00	\$0.00	\$43.19	\$57.06
4th year	79.78	\$31.70	\$8.51	\$6.00	\$0.85	\$0.00	\$0.00	\$0.09	\$0.00	\$0.00	\$47.15	\$62.99

Special Calculation Note : Other: Education & Safety Fund is \$0.09 per hour.

Ratio :

Jurisdiction (* denotes special jurisdictional note) :

For every (3) Operating Engineer Journeymen employed by the company , there may be employed (1) Registered Apprentice or Trainee Engineer through the referral when they are available. An apprentice, while employed as part of a crew per Article VIII paragraph 65, will not be subject the apprenticeship ratios in this collective bargaining agreement.

ASHTABULA, CUYAHOGA, ERIE, GEAUGA, LAKE, LORAIN, MEDINA, PORTAGE, SUMMIT

Special Jurisdictional Note :

Details :

**Apprentices will receive a 10% increase on top of the percentages listed above provided they are operating mobile equipment. Mechanic Trainees will receive 10% if required to have a CDL.

Class 1 - Air Compressors on Steel Erection; Asphalt Plant Engineers (Cleveland District Only); Barrier Moving Machine; Boiler Operators, Compressor Operators, or Generators, when mounted on a rig; Boom Trucks (all types); Cableways; Cherry Pickers; Combination- Concrete mixers & Towers; Concrete Pumps; Concrete Plants (over 4 yd capacity); Cranes (all types); Derricks (all types); Draglines; Elevating Graders or Euclid Loaders; Gradalls; Helicopter Crew (Operator- hoist or winch); Hoes (all types); Hoisting Engines; Hoisting Engines, on shaft or tunnel work; Hydraulic Gantry (lifting system); Locomotives (standard guage); Maintenance Operators (class A); Mixers, paving (single or double drum); Piledriving Machines (all types); Power Shovels, Prentice Loader; Quad 9 (double pusher); Rail Tamper (with automatic lifting and aligning device); Refrigerating Machines (freezer operation); Rotary Drills, on caisson work; Side Booms; Slip Form Pavers; Tower Dericks; Trench Machines; Truck Mounted Concrete Pumps; Tug Boats; Tunnel Machines and /or Mining Machines; Wheel Excavators;Industrial-type tractors; Jet Engine - Dryer (D8 or D9) Diesel Tractors Mucking Machines; Multiple Scrapers; Tree Shreddes. Rough Terrain Fork-lift with Winch/Hoist; Compact Cranes,track or rubber over 4,000 pound capacity, self-erecting cranes:stationary,track or truck (all configurations) bucket trench machines (over 24 inches wide).

Class 2 - Asphalt Pavers; Automatic Subgrade Machines, self-propelled (CMI-type); Bobcat-type and /or skid steer loader with hoe attachment greater than 7000 lbs.; Boring Machine Operators (more than 48 inches); Bulldozers; ;Endloaders; Hydro Milling Machine; Kolman-type Loaders (production type-dirt); Lead Greasemen; Maintenance Operators, Class B (Portage and Summit Counties only); Pettibone-Rail Equipment; Power Graders; Power Scrapers; Push Cats; Lighting and Traffic Signal Installation Equipment includes all groups or classifications; Trench Machines (24inch wide and under); Vermeer Type Concrete saw. Material Transfer Equipment (Shuttle buggy) Asphalt All rotomills, grinders and planers of all types. Horizontal Directional Drill (Over 50,000 ft.lbs.thrust and over).

Class 3 - A-Frames; Air Compressors, on tunnel work (low Pressure); All Asphalt Rollers; Asphalt Plant Engineers (Portage and Summit Counties only); Bobcat-type and/or skid steer loader with or without attachments; Power Boilers (15 lbs pressure and over); Highway Drills (all types); Pump Operators (installing or operating well Points); Pumps (4 inch and over discharge); Railroad Tie Inserter/Remover; Rotovator (lime-soil Stabilzer); Switch & Tie Tampers (without lifting and aligning device); Locomotives (narrow gage); Mixers, concrete (more than one bag capacity); Mixers, one bag capacity (side loader); Utilities Operators, (small equipment); Welding Machines and Generators; Material hoist/elevators. Articulating/straight bed end dumps if assigned (minus \$4.00 per hour)

Class 4 - Ballast Re-loacator; Backfillers and Tampers; Batch Plant Operators; Bar and Joint Installing Machines; Boring Machine Operators (48 inch or less); Bull Floats; Burlap and Curing Machines; Concrete Plants (capacity 4 yd and under); Conveyors (highway); Concrete Saws (multiple); Crushers; Deckhands; Farm type tractors, with attachments (highway); Finishing Machines; Hydro Hammers; Hydro Seeders; Pavement Breakers (hydraulic or cable); Plant Mixers; Post Drivers; Post Hole Diggers; Power Brush Burners; Power Form Handling Equipment; Firemen, Floating Equipment (all types); Fork Lifts (highway), except masonry; Form Trenchers; Road Widening Trenchers; Rollers (brick, grade, macadam); Self-Propelled Power Spreaders; Self-Propelled Sub-Graders; Tractors, pulling sheepsfoot rollers or graders; Steam Firemen; Vibratory Compactors, with integral power.

Class 5 - Compressors (portable, Sewer, Heavy and Highway); Generators; Inboard-Outboard Motor Boat Launches; Masonry Fork Lifts; Oilers/Helpers; Power Driven Heaters (oil fired); Power Scrubbers; Power Sweepers; Pumps (under 4 inch discharge); Signalmen; Drum Fireman (in Asphalt Plant); Oil Heaters (Asphalt Plant); Tire Repairmen; VAC/ALLS; Fueling and greasing (Primary Operator with Specialized CDL Endorsement Add \$3.00/hr), compact cranes; track or rubber under 4,000 pounds.

Class 6 - Master Mechanic

Prevailing Wage Rate

Skilled Crafts

Name of Union: Painter Local 505

Change # : LCN01-2020fbLoc505

Craft : Drywall Finisher Effective Date : 07/02/2020 Last Posted : 07/02/2020

	BHR		Fringe Benefit Payments					Irrevocable Fund		Total PWR	Overtime Rate	
			H&W	Pension	App Tr.	Vac.	Annuity	Other	LECET (*)			MISC (*)
Classification												
Painter Drywall Finisher	\$30.19		\$7.17	\$6.08	\$0.40	\$0.00	\$3.47	\$0.00	\$0.00	\$0.00	\$47.31	\$62.41
Apprentice	Percent											
1st 6 months	45.00	\$13.59	\$6.91	\$1.84	\$0.40	\$0.00	\$0.00	\$0.00	\$0.00	\$0.00	\$22.74	\$29.53
2nd 6 months	50.00	\$15.10	\$6.91	\$1.94	\$0.40	\$0.00	\$0.00	\$0.00	\$0.00	\$0.00	\$24.35	\$31.89
3rd 6 months	55.00	\$16.60	\$6.91	\$2.39	\$0.40	\$0.00	\$1.91	\$0.00	\$0.00	\$0.00	\$28.21	\$36.52
4th 6 months	60.00	\$18.11	\$6.91	\$2.49	\$0.40	\$0.00	\$2.08	\$0.00	\$0.00	\$0.00	\$29.99	\$39.05
5th 6 months	65.00	\$19.62	\$6.91	\$2.94	\$0.40	\$0.00	\$2.26	\$0.00	\$0.00	\$0.00	\$32.13	\$41.95
6th 6 months	70.00	\$21.13	\$6.91	\$3.04	\$0.40	\$0.00	\$2.43	\$0.00	\$0.00	\$0.00	\$33.91	\$44.48

Special Calculation Note : No special calculation for this classification.

Ratio :
Apprentice to 1 Journeyman

Jurisdiction (* denotes special jurisdictional note)
ASHTABULA, CUYAHOGA, GEAUGA, LAKE, LORAIN,
PORTAGE*, SUMMIT*

Special Jurisdictional Note : Portage & Summit North of the East-West Turnpike.

Details :

Prevailing Wage Rate Skilled Crafts

Name of Union: Painter Local 707

Change # : LCN01-2020fbLoc707

Craft : Painter Effective Date : 07/02/2020 Last Posted : 07/02/2020

	BHR		Fringe Benefit Payments					Irrevocable Fund		Total PWR	Overtime Rate	
			H&W	Pension	App Tr.	Vac.	Annuity	Other	LECET (*)			MISC (*)
Classification												
Painter Brush Roll	\$28.96		\$7.17	\$5.08	\$0.40	\$0.00	\$4.15	\$0.00	\$0.00	\$0.00	\$45.76	\$60.24
Paperhanger	\$28.96		\$7.17	\$5.08	\$0.40	\$0.00	\$4.15	\$0.00	\$0.00	\$0.00	\$45.76	\$60.24
Sandblasting & Buffing	\$29.36		\$7.17	\$5.08	\$0.40	\$0.00	\$4.15	\$0.00	\$0.00	\$0.00	\$46.16	\$60.84
Spray Painting	\$29.66		\$7.17	\$5.08	\$0.40	\$0.00	\$4.15	\$0.00	\$0.00	\$0.00	\$46.46	\$61.29
REPAINT Brush Roll & Paperhanger	\$27.46		\$7.17	\$5.08	\$0.40	\$0.00	\$4.15	\$0.00	\$0.00	\$0.00	\$44.26	\$57.99
REPAINT Sandblasting & Buffing	\$27.86		\$7.17	\$5.08	\$0.40	\$0.00	\$4.15	\$0.00	\$0.00	\$0.00	\$44.66	\$58.59
REPAINT Spray Painting	\$28.16		\$7.17	\$5.08	\$0.40	\$0.00	\$4.15	\$0.00	\$0.00	\$0.00	\$44.96	\$59.04
Apprentice - Painter	Percent											
1st 6 months	45.00	\$13.03	\$7.17	\$1.59	\$0.40	\$0.00	\$0.00	\$0.00	\$0.00	\$0.00	\$22.19	\$28.71
2nd 6 months	50.00	\$14.48	\$7.17	\$1.64	\$0.40	\$0.00	\$0.00	\$0.00	\$0.00	\$0.00	\$23.69	\$30.93
3rd 6 months	55.00	\$15.93	\$7.17	\$2.13	\$0.40	\$0.00	\$2.28	\$0.00	\$0.00	\$0.00	\$27.91	\$35.87
4th 6 months	60.00	\$17.38	\$7.17	\$2.17	\$0.40	\$0.00	\$2.49	\$0.00	\$0.00	\$0.00	\$29.61	\$38.29
5th 6 months	65.00	\$18.82	\$7.17	\$2.52	\$0.40	\$0.00	\$2.70	\$0.00	\$0.00	\$0.00	\$31.61	\$41.03
6th 6 months	70.00	\$20.27	\$7.17	\$2.56	\$0.40	\$0.00	\$2.91	\$0.00	\$0.00	\$0.00	\$33.31	\$43.45
7th 6 months	75.00	\$21.72	\$7.17	\$3.31	\$0.40	\$0.00	\$3.11	\$0.00	\$0.00	\$0.00	\$35.71	\$46.57
8th 6 months	80.00	\$23.17	\$7.17	\$3.35	\$0.40	\$0.00	\$3.32	\$0.00	\$0.00	\$0.00	\$37.41	\$48.99

Special Calculation Note : Apprentice pay based on percentage of above appropriate classification.

Ratio :
Apprentice to 1 Journeyman

Jurisdiction (* denotes special jurisdictional note) :
ASHTABULA, CUYAHOGA, GEAUGA, LAKE, LORAIN,
PORTAGE*, SUMMIT*

Special Jurisdictional Note : Portage & Summit North of the East-West Turnpike.

Details :

Application of Catalytic materials under class 3 hazardous per MSDS - .65 per hour above the Job Classification basic hourly rate.
Application of Catalytic materials under class 4 hazardous per MSDS - 1.00 per hour above the Job Classification basic hourly rate.

2nd Year	60.00	\$15.05	\$6.50	\$1.98	\$0.35	\$0.00	\$0.50	\$0.00	\$0.00	\$0.00	\$24.38	\$31.90
3rd Year	70.00	\$17.56	\$6.50	\$2.32	\$0.35	\$0.00	\$0.50	\$0.00	\$0.00	\$0.00	\$27.23	\$36.00
4th Year	80.00	\$20.06	\$6.50	\$3.00	\$0.35	\$0.00	\$0.50	\$0.00	\$0.00	\$0.00	\$30.41	\$40.45

Special Calculation Note : Apprentice pay based on percentage of above appropriate classification.

Ratio :

3 Journeymen to 1 Apprentice

Jurisdiction (* denotes special jurisdictional note) :

MEDINA, PORTAGE*, SUMMIT*

Special Jurisdictional Note : Summit Cnty: North to and including the Ohio Turnpike,
Portage Cnty: North to and including the Ohio Turnpike

Details :

Night Rate: from 10:00 p.m. to 6:00 a.m. of the regular work week shall be paid for at the rate of \$1.00 per hour above the classification worked rate.

CLERMONT, CLINTON, COLUMBIANA,
COSHOCTON, CRAWFORD, CUYAHOGA,
DARKE, DEFIANCE, DELAWARE, ERIE,
FAIRFIELD, FAYETTE, FRANKLIN, FULTON,
GALLIA, GEAUGA, GREENE, GUERNSEY,
HAMILTON, HANCOCK, HARDIN,
HARRISON, HENRY, HIGHLAND, HOCKING,
HOLMES, HURON, JACKSON, JEFFERSON,
KNOX, LAKE, LAWRENCE, LICKING,
LOGAN, LORAIN, LUCAS, MADISON,
MAHONING, MARION, MEDINA, MEIGS,
MERCER, MIAMI, MONROE,
MONTGOMERY, MORGAN, MORROW,
MUSKINGUM, NOBLE, OTTAWA,
PAULDING, PERRY, PICKAWAY, PIKE,
PORTAGE, PREBLE, PUTNAM, RICHLAND,
ROSS, SANDUSKY, SCIOTO, SENECA,
SHELBY, STARK, SUMMIT, TRUMBULL,
TUSCARAWAS, UNION, VAN WERT,
VINTON, WARREN, WASHINGTON, WAYNE,
WILLIAMS, WOOD, WYANDOT

Special Jurisdictional Note :

Details :

Top Helper: Shall perform the responsibilities of a Helper and be responsible for the setup, break down, safety and quality of the company's product.

Helper : Shall be responsible for performing tasks in refinishing, compliance with safety procedures, setting up and breaking down job sites, scaffolding and swing stages and preparing surfaces for refinishing including but not limited to, masking and stripping and cleaning, oxidizing, polishing and scratch removal on various surfaces

Class A Workers: Less than 1 Year of Service.

Class B Workers: More than 1 and less than 8 Years of Service.

Class C Workers: More than 8 Years of Service.

Metal Polisher Scope of Work: Polishing, buffing, stripping, coloring, lacquering, spraying, cleaning and maintenance of ornamental and architectural metals, iron, bronze, nickel, aluminum and stainless steel and in mental specialty work, various stone finishes, stone specialty work and any other work pertaining to the finishing of metal, stones, woods, and any window washing/cleaning done in conjunction with this work, using chemicals, solvents, coatings and hand applied lacquer thinner, removing scratches from mirror finished metals, burnishing of bronze, statuary finishes on exterior and interior surfaces and the use of all tools required to perform such work, including but not limited to polishes, spray equipment and scaffolding.

Swing State Rate: All work on scaffold 4 sections or higher, including any boom lifts and swing stage scaffolds including the rigging and derigging of hanging/suspended swing stage systems and rappelling/bolson chair work, ADD \$1.50 per hour.

Prevailing Wage Rate Skilled Crafts

Name of Union: Painter/Sign Local 639 (A)

Change # : CN01-2009Loc639A

Craft : Painter Effective Date : 03/06/2009 Last Posted : 03/06/2009

Fringe Benefit Payments										
	BHR	H&W	Pension	App Tr.	Vac.	Annuity	Other	Total PWR	Overtime Rate	
Classification										
Painter-Sign Erector	\$19.98	\$4.46	\$1.00	\$0.25	\$1.68	\$0.00	\$0.00	\$27.37	\$37.36	
Serviceman	\$19.98	\$4.46	\$1.00	\$0.25	\$1.68	\$0.00	\$0.00	\$27.37	\$37.36	
Metal Sign-Frabricator-	\$19.98	\$4.46	\$1.00	\$0.25	\$1.68	\$0.00	\$0.00	\$27.37	\$37.36	
Neon Bender Pattern Maker	\$19.98	\$4.46	\$1.00	\$0.25	\$1.68	\$0.00	\$0.00	\$27.37	\$37.36	
Computer Operator	\$18.98	\$4.46	\$1.00	\$0.25	\$1.61	\$0.00	\$0.00	\$26.30	\$35.79	
Router	\$18.98	\$4.46	\$1.00	\$0.25	\$1.61	\$0.00	\$0.00	\$26.30	\$35.79	
Plastic-Wood Fabricator	\$18.98	\$4.46	\$1.00	\$0.25	\$1.61	\$0.00	\$0.00	\$26.30	\$35.79	
Vinyl Applicator	\$18.98	\$4.46	\$1.00	\$0.25	\$1.61	\$0.00	\$0.00	\$26.30	\$35.79	
Apprentice For Sign Service, Metal, Neon, Pattern	Percent									
1000 hrs	50.00	\$9.99	\$4.46	\$1.00	\$0.25	\$1.03	\$0.00	\$16.73	\$21.73	
2000 hrs	55.00	\$10.99	\$4.46	\$1.00	\$0.25	\$0.37	\$0.00	\$17.07	\$22.56	
3000 hrs	60.00	\$11.99	\$4.46	\$1.00	\$0.25	\$0.37	\$0.00	\$18.07	\$24.06	
4000 hrs	65.00	\$12.99	\$4.46	\$1.00	\$0.25	\$0.37	\$0.00	\$19.07	\$25.56	
5000 hrs	70.00	\$13.99	\$4.46	\$1.00	\$0.25	\$0.37	\$0.00	\$20.07	\$27.06	
6000 hrs	85.00	\$16.98	\$4.46	\$1.00	\$0.25	\$0.37	\$0.00	\$23.06	\$31.55	
7000 hrs	90.00	\$17.98	\$4.46	\$1.00	\$0.25	\$0.37	\$0.00	\$24.06	\$33.05	

Special Calculation Note : Apprentice Rates For: Computer Operator, Router, Plastic-Wood Fabricator Vinyl Application

- 1000 hrs 50% plus (\$4.46 h&w)+(\$1.00 pension)+(\$0.25 apprentice training) + vacation \$0.99
- 2000 hrs 55% plus (\$4.46 h&w)+(\$1.00 pension)+(\$0.25 apprentice training) + vacation \$0.37
- 3000 hrs 65% plus (\$4.46 h&w)+(\$1.00 pension)+(\$0.25 apprentice training) + vacation \$0.37
- 4000 hrs 50% plus (\$4.46 h&w)+(\$1.00 pension)+(\$0.25 apprentice training) + vacation \$0.37
- 5000 hrs 70% plus (\$4.46 h&w)+(\$1.00 pension)+(\$0.25 apprentice training) + vacation \$0.37
- 6000 hrs 85% plus (\$4.46 h&w)+(\$1.00 pension)+(\$0.25 apprentice training) + vacation \$0.37
- 7000 hrs 90% plus (\$4.46 h&w)+(\$1.00 pension)+(\$0.25 apprentice training) + vacation \$0.37

Ratio : **Jurisdiction (* denotes special jurisdictional note) :**

ASHLAND, ASHTABULA, CUYAHOGA, ERIE,
GEAUGA, LAKE, LORAIN, MEDINA, PORTAGE,
RICHLAND, STARK, SUMMIT

Special Jurisdictional Note :

Details :

Sign and display work shall include but not limited: to the making and installation of all signs and servicing of the same, lettering and pictorial work of any kind, including vinyl signs and vinyl substrates and the preparing for the finishing of same, be it by hand, brush, roller, spray, mechanical or computer aided and by any other method or process pertaining to same: they shall have control of all branches, methods and processes of screen process work: tube bending and display work such as creating, building and finishing of all display matter and its related operations used for advertising purposes, including all lettering whether it be done by hand, mechanical or computer aided or by any other method or process pertaining to same: the construction, erection and maintenance of all billboards and all communication advertising.

Prevailing Wage Rate Skilled Crafts

Name of Union: Painter Local 639 Zone 1 Sign

Change # : LCN01-2019fbLoc639

Craft : Painter Effective Date : 06/12/2019 Last Posted : 06/12/2019

Classification	BHR		Fringe Benefit Payments						Irrevocable Fund		Total PWR	Overtime Rate
			H&W	Pension	App Tr.	Vac.	Annuity	Other	LECET (*)	MISC (*)		
Painter Sign Erector Service/Pattern/Metal Fab/Neon Class A	\$23.34		\$6.66	\$4.75	\$0.25	\$0.67	\$0.00	\$0.94	\$0.00	\$0.00	\$36.61	\$48.28
Painter Sign Erector/Service/Pattern/Metal Fab/Neon Class B	\$23.34		\$6.66	\$4.75	\$0.25	\$1.35	\$0.00	\$0.94	\$0.00	\$0.00	\$37.29	\$48.96
Painter Sign Erector/Service/Pattern/Metal Fab/Neon Class C	\$23.34		\$6.66	\$4.75	\$0.25	\$2.02	\$0.00	\$0.94	\$0.00	\$0.00	\$37.96	\$49.63
Painter Sign Erector/Service/Pattern/Metal Fab/Neon Class D	\$23.34		\$6.66	\$4.75	\$0.25	\$2.69	\$0.00	\$0.94	\$0.00	\$0.00	\$38.63	\$50.30
Computer Operator, Router, Spray Painter/Wood Class A	\$21.83		\$6.66	\$4.75	\$0.25	\$0.64	\$0.00	\$0.90	\$0.00	\$0.00	\$35.03	\$45.95
Computer Operator, Router, Spray Painter/Wood Class B	\$21.83		\$6.66	\$4.75	\$0.25	\$1.29	\$0.00	\$0.90	\$0.00	\$0.00	\$35.68	\$46.60
Computer Operator, Router, Spray Painter/Wood Class C	\$21.83		\$6.66	\$4.75	\$0.25	\$1.93	\$0.00	\$0.90	\$0.00	\$0.00	\$36.32	\$47.24
Computer Operator, Router, Spray Painter/Wood Class D	\$21.83		\$6.66	\$4.75	\$0.25	\$2.58	\$0.00	\$0.90	\$0.00	\$0.00	\$36.97	\$47.89
Final Assembly,Helper Class A	\$17.36		\$6.66	\$4.75	\$0.25	\$0.56	\$0.00	\$0.78	\$0.00	\$0.00	\$30.36	\$39.04
Final Assembly,Helper Class B	\$17.36		\$6.66	\$4.75	\$0.25	\$1.12	\$0.00	\$0.78	\$0.00	\$0.00	\$30.92	\$39.60
Final Assembly,Helper Class C	\$17.36		\$6.66	\$4.75	\$0.25	\$1.67	\$0.00	\$0.78	\$0.00	\$0.00	\$31.47	\$40.15
Final Assembly,Helper Class D	\$17.36		\$6.66	\$4.75	\$0.25	\$2.23	\$0.00	\$0.78	\$0.00	\$0.00	\$32.03	\$40.71
Apprentice	Percent											
1-2000 hrs	49.98	\$11.67	\$6.66	\$4.75	\$0.25	\$0.00	\$0.00	\$0.63	\$0.00	\$0.00	\$23.96	\$29.79
2001-3000 hrs	55.00	\$12.84	\$6.66	\$4.75	\$0.25	\$1.88	\$0.00	\$0.66	\$0.00	\$0.00	\$27.04	\$33.46
3001-4000 hrs	60.00	\$14.00	\$6.66	\$4.75	\$0.25	\$1.97	\$0.00	\$0.69	\$0.00	\$0.00	\$28.32	\$35.33
4001-5000 hrs	65.00	\$15.17	\$6.66	\$4.75	\$0.25	\$2.06	\$0.00	\$0.72	\$0.00	\$0.00	\$29.61	\$37.20
5001-6000 hrs	70.00	\$16.34	\$6.66	\$4.75	\$0.25	\$2.15	\$0.00	\$0.75	\$0.00	\$0.00	\$30.90	\$39.07
6001-7000 hrs	85.00	\$19.84	\$6.66	\$4.75	\$0.25	\$2.42	\$0.00	\$0.85	\$0.00	\$0.00	\$34.77	\$44.69
7001-8000 hrs	90.00	\$21.01	\$6.66	\$4.75	\$0.25	\$2.51	\$0.00	\$0.88	\$0.00	\$0.00	\$36.06	\$46.56

Special Calculation Note : Other is for paid holidays. Apprentice Pay Rate should be based on proper Classification.

Ratio :

Jurisdiction (* denotes special jurisdictional note) :
ASHLAND, ASHTABULA, CUYAHOGA, GEAUGA, LAKE,
MEDINA, PORTAGE, RICHLAND, SUMMIT

Special Jurisdictional Note :

Details :

- Class A Worker: More than 1 year but less that 2 years.
- Class B Worker: More than 2 years but less than 10 years.
- Class C Worker: More than 10 years but less that 20 years.
- Class D Worker: More than 20 years

Prevailing Wage Rate Skilled Crafts

Name of Union: Painter Local 841 Zone I Bridge Painter

Change # : LCN01-2019fbLoc841

Craft : Painter Effective Date : 10/09/2019 Last Posted : 10/09/2019

	BHR		Fringe Benefit Payments					Irrevocable Fund		Total PWR	Overtime Rate	
			H&W	Pension	App Tr.	Vac.	Annuity	Other	LECET (*)			MISC (*)
Classification												
Painter Bridge Blaster Class 1	\$35.90		\$6.70	\$7.17	\$0.35	\$0.00	\$0.50	\$0.00	\$0.00	\$0.00	\$50.62	\$68.57
Class 2 Bridge Painter, Rigger, Containment Builder, Spot Blaster	\$32.90		\$6.70	\$7.17	\$0.35	\$0.00	\$0.50	\$0.00	\$0.00	\$0.00	\$47.62	\$64.07
Class 3 Equipment Operator/Field Mechanic, Grit Reclamation, Paint Mixer, Traffic Control, Boat Person, Dive (0-5 Years Exp)	\$25.90		\$6.70	\$7.17	\$0.35	\$0.00	\$0.50	\$0.00	\$0.00	\$0.00	\$40.62	\$53.57
Class 3 Equipment Operator/Field Mechanic, Grit Reclamation, Paint Mixer, Traffic Control, Boat Person, Dive (5 plus Years Exp).	\$28.90		\$6.70	\$7.17	\$0.35	\$0.00	\$0.50	\$0.00	\$0.00	\$0.00	\$43.62	\$58.07
Class 4 Concrete Sealing, Concrete Blasting/Power Washing/Etc.	\$28.90		\$6.70	\$7.17	\$0.35	\$0.00	\$0.50	\$0.00	\$0.00	\$0.00	\$43.62	\$58.07
Class 5 Quality Control/Quality Assurance Traffic Safety, Competent Person.	\$28.90		\$6.70	\$7.17	\$0.35	\$0.00	\$0.50	\$0.00	\$0.00	\$0.00	\$43.62	\$58.07
Apprentice	Percent											
1st Year	50.00	\$17.95	\$6.70	\$2.55	\$0.35	\$0.00	\$0.50	\$0.00	\$0.00	\$0.00	\$28.05	\$37.03
2nd Year	60.00	\$21.54	\$6.70	\$2.94	\$0.35	\$0.00	\$0.50	\$0.00	\$0.00	\$0.00	\$32.03	\$42.80
3rd year	70.00	\$25.13	\$6.70	\$3.34	\$0.35	\$0.00	\$0.50	\$0.00	\$0.00	\$0.00	\$36.02	\$48.59
4th Year	80.00	\$28.72	\$6.70	\$4.08	\$0.35	\$0.00	\$0.50	\$0.00	\$0.00	\$0.00	\$40.35	\$54.71

Special Calculation Note : Apprentice pay based on percentage of above appropriate classification.

Ratio :

1 Journeymen to 1 Apprentice

Jurisdiction (* denotes special jurisdictional note) :

MEDINA, PORTAGE*, SUMMIT*

Special Jurisdictional Note : Summit County: North to and including the Ohio Turnpike, Portage County: North to and including the Ohio Turnpike

Details :

Class 1 – Abrasive blasting of any kind

Class 2 – Bridge painting, coating applications of any kind. All steel surface preparation other than abrasive blasting. All necessary rigging and containment building and all remedial/ spot blasting.

Class 3 – Tend to all equipment including but not limited to abrasive blasting, power washing, spray painting, forklifts, hoists, truck, etc. Load and unloading trucks, handle materials, man safety boats, handle traffic control, clean up/ vacuum abrasive blast materials and related tasks.

Class 4 – All aspects of concrete coating/ sealing including but not limited to preparation, containment, etc.

Class 5 – Verify and record that all work is completed according to job specifications. Assure that all health and safety standards are adhered to. Assure all traffic is safely handled.

Prevailing Wage Rate Skilled Crafts

Name of Union: Painter Local 841 Industrial

Change # : LCN01-2013fbLoc841Ind

Craft : Painter Effective Date : 06/05/2013 Last Posted : 06/05/2013

	BHR		Fringe Benefit Payments					Irrevocable Fund		Total PWR	Overtime Rate	
			H&W	Pension	App Tr.	Vac.	Annuity	Other	LECET (*)			MISC (*)
Classification												
Painter Bridge Class 1	\$39.20		\$6.25	\$5.32	\$0.18	\$0.00	\$0.00	\$0.00	\$0.00	\$0.00	\$50.95	\$70.55
Apprentice	Percent											
1st 6 months	45.00	\$17.64	\$6.25	\$1.00	\$0.18	\$0.00	\$0.00	\$0.00	\$0.00	\$0.00	\$25.07	\$33.89
2nd 6 months	50.00	\$19.60	\$6.25	\$1.00	\$0.18	\$0.00	\$0.00	\$0.00	\$0.00	\$0.00	\$27.03	\$36.83
3rd 6 months	55.00	\$21.56	\$6.25	\$1.33	\$0.18	\$0.00	\$0.00	\$0.00	\$0.00	\$0.00	\$29.32	\$40.10
4th 6 months	60.00	\$23.52	\$6.25	\$1.33	\$0.18	\$0.00	\$0.00	\$0.00	\$0.00	\$0.00	\$31.28	\$43.04
5th 6 months	65.00	\$25.48	\$6.25	\$1.67	\$0.18	\$0.00	\$0.00	\$0.00	\$0.00	\$0.00	\$33.58	\$46.32
6th 6 months	70.00	\$27.44	\$6.25	\$1.67	\$0.18	\$0.00	\$0.00	\$0.00	\$0.00	\$0.00	\$35.54	\$49.26
7th 6 months	75.00	\$29.40	\$6.25	\$2.35	\$0.18	\$0.00	\$0.00	\$0.00	\$0.00	\$0.00	\$38.18	\$52.88
8th 6 months	80.00	\$31.36	\$6.25	\$2.35	\$0.18	\$0.00	\$0.00	\$0.00	\$0.00	\$0.00	\$40.14	\$55.82

Special Calculation Note : Apprentice pay based on percentage of above appropriate classification.

Ratio : 1 Journeymen to 1 Apprentice
Jurisdiction (* denotes special jurisdictional note) : MEDINA, PORTAGE*, SUMMIT*

Special Jurisdictional Note : Summit County: North to and including the Ohio Turnpike,

Portage County: North to and including the Ohio Turnpike

Details :

Painter Bridge Class 1 is defined as (Public & Commerce transportation, steel or galvanized Bridges, Tunnels, & related support items (concrete). All phases of work including inspection) Night Rat from 10:00 p.m. to 6:00 a.m. of the regular work week shall be paid at the rate of \$1.00 per hour above the classification worked rate.

Prevailing Wage Rate Skilled Crafts

Name of Union: Painter Local 841 Zone I

Change # : LCN01-2019fbLoc841

Craft : Painter Effective Date : 10/09/2019 Last Posted : 10/09/2019

	BHR		Fringe Benefit Payments					Irrevocable Fund		Total PWR	Overtime Rate	
			H&W	Pension	App Tr.	Vac.	Annuity	Other	LECET (*)			MISC (*)
Classification												
Painter Brush Roll	\$26.23		\$6.70	\$7.17	\$0.35	\$0.00	\$0.50	\$0.00	\$0.00	\$0.00	\$40.95	\$54.07
Paperhanger	\$26.23		\$6.70	\$7.17	\$0.35	\$0.00	\$0.50	\$0.00	\$0.00	\$0.00	\$40.95	\$54.07
Painter Spray Gun Operator Any and All Coatings)	\$27.08		\$6.70	\$7.17	\$0.35	\$0.00	\$0.50	\$0.00	\$0.00	\$0.00	\$41.80	\$55.34
Swing Scaffold, Bosum Chair, & Window Jacks	\$26.98		\$6.70	\$7.17	\$0.35	\$0.00	\$0.50	\$0.00	\$0.00	\$0.00	\$41.70	\$55.19
Sandblast, Painting of Standpipes, etc. from Scaffolds Open Structural Steel, Standpipes and Water Towers	\$27.48		\$6.70	\$7.17	\$0.35	\$0.00	\$0.50	\$0.00	\$0.00	\$0.00	\$42.20	\$55.94
Epoxy Application	\$26.88		\$6.70	\$7.17	\$0.35	\$0.00	\$0.50	\$0.00	\$0.00	\$0.00	\$41.60	\$55.04
Synthetic Exterior, Lead Abatement, Asbestos Removal	\$27.48		\$6.70	\$7.17	\$0.35	\$0.00	\$0.50	\$0.00	\$0.00	\$0.00	\$42.20	\$55.94
Apprentice	Percent											
1st Year	50.00	\$13.12	\$6.70	\$2.55	\$0.35	\$0.00	\$0.50	\$0.00	\$0.00	\$0.00	\$23.22	\$29.77
2nd Year	60.00	\$15.74	\$6.70	\$2.94	\$0.35	\$0.00	\$0.50	\$0.00	\$0.00	\$0.00	\$26.23	\$34.10
3rd Year	70.00	\$18.36	\$6.70	\$3.34	\$0.35	\$0.00	\$0.50	\$0.00	\$0.00	\$0.00	\$29.25	\$38.43
4th Year	80.00	\$20.98	\$6.70	\$4.08	\$0.35	\$0.00	\$0.50	\$0.00	\$0.00	\$0.00	\$32.61	\$43.11

Special Calculation Note : Apprentice pay based on percentage of above appropriate classification.

Ratio :
1 Journeymen to 1 Apprentice

Jurisdiction (* denotes special jurisdictional note) :
MEDINA, PORTAGE*, SUMMIT*

Special Jurisdictional Note : Summit Cnty: North to and including the Ohio Turnpike, Portage Cnty: North to and including the Ohio Turnpike

Details :

Prevailing Wage Rate Skilled Crafts

Name of Union: Painter Local 841 Zone I

Change # : LCN01-2019fbLoc841

Craft : Drywall Finisher Effective Date : 10/09/2019 Last Posted : 10/09/2019

	BHR	Fringe Benefit Payments						Irrevocable Fund		Total PWR	Overtime Rate
		H&W	Pension	App Tr.	Vac.	Annuity	Other	LECET (*)	MISC (*)		
Classification											
Painter Drywall Finisher/PainterTaper	\$27.48	\$6.70	\$7.17	\$0.35	\$0.00	\$0.50	\$0.00	\$0.00	\$0.00	\$42.20	\$55.94
Automatic Tools	\$27.48	\$6.70	\$7.17	\$0.35	\$0.00	\$0.50	\$0.00	\$0.00	\$0.00	\$42.20	\$55.94
Apprentice	Percent										
1st Year	50.00	\$13.74	\$6.70	\$2.55	\$0.35	\$0.50	\$0.00	\$0.00	\$0.00	\$23.84	\$30.71
2nd Year	65.00	\$17.86	\$6.70	\$3.31	\$0.35	\$0.50	\$0.00	\$0.00	\$0.00	\$28.72	\$37.65
3rd Year	80.00	\$21.98	\$6.70	\$4.08	\$0.35	\$0.50	\$0.00	\$0.00	\$0.00	\$33.61	\$44.61

Special Calculation Note : Apprentice pay based on percentage of above appropriate classification.

Ratio :

1 Apprentice to 1 Journeyman

Jurisdiction (* denotes special jurisdictional note) :

MEDINA, PORTAGE*, SUMMIT*

Special Jurisdictional Note : Summit County North to and including the Ohio Turnpike, Portage Cnty: North to and including the Ohio Turnpike

Details :

Prevailing Wage Rate

Skilled Crafts

Name of Union: Painter Local 707 HwyHwy

Change # : LCN01-2020fbLoc707Ind

Craft : Painter Effective Date : 07/02/2020 Last Posted : 07/02/2020

Classification	BHR		Fringe Benefit Payments					Irrevocable Fund		Total PWR	Overtime Rate	
			H&W	Pension	App Tr.	Vac.	Annuity	Other	LECET (*)			MISC (*)
Painter Bridge Class 1 Bridge Blaster	\$35.22		\$7.17	\$5.08	\$0.40	\$0.00	\$4.15	\$0.00	\$0.00	\$0.00	\$52.02	\$69.63
Class 2 Bridge Painter, Rigger/Containment Builder, Spot Blaster	\$32.22		\$7.17	\$5.08	\$0.40	\$0.00	\$4.15	\$0.00	\$0.00	\$0.00	\$49.02	\$65.13
Class 3 Equipment Operator/Field Mechanic, Grit Reclamation, Paint Mixer, Traffic Control Boat Person, Driver (0-5 Years Exp.)	\$25.22		\$7.17	\$5.08	\$0.40	\$0.00	\$4.15	\$0.00	\$0.00	\$0.00	\$42.02	\$54.63
Class 3 Equipment Operator/Field Mechanic, Grit Reclamation, Paint Mixer, Traffic Control Boat Person, Driver (5 Plus Years Exp.)	\$28.22		\$7.17	\$5.08	\$0.40	\$0.00	\$4.15	\$0.00	\$0.00	\$0.00	\$45.02	\$59.13
Class 4 Concrete Sealing, Concrete Blasting/Power Washing/Etc	\$24.22		\$7.17	\$5.08	\$0.40	\$0.00	\$4.15	\$0.00	\$0.00	\$0.00	\$41.02	\$53.13
Class 5 Quality Control, Quality Assurance, Traffic Safety, Competent Person	\$28.22		\$7.17	\$5.08	\$0.40	\$0.00	\$4.15	\$0.00	\$0.00	\$0.00	\$45.02	\$59.13
Apprentice - Painter	Percent											
1st 6 months	45.00	\$15.85	\$7.17	\$1.59	\$0.40	\$0.00	\$0.00	\$0.00	\$0.00	\$0.00	\$25.01	\$32.93
2nd 6 months	50.00	\$17.61	\$7.17	\$1.64	\$0.40	\$0.00	\$0.00	\$0.00	\$0.00	\$0.00	\$26.82	\$35.63
3rd 6 months	55.00	\$19.37	\$7.17	\$2.13	\$0.40	\$0.00	\$2.28	\$0.00	\$0.00	\$0.00	\$31.35	\$41.04
4th 6 months	60.00	\$21.13	\$7.17	\$2.17	\$0.40	\$0.00	\$2.49	\$0.00	\$0.00	\$0.00	\$33.36	\$43.93
5th 6 months	65.00	\$22.89	\$7.17	\$2.52	\$0.40	\$0.00	\$2.70	\$0.00	\$0.00	\$0.00	\$35.68	\$47.13
6th 6 months	70.00	\$24.65	\$7.17	\$2.56	\$0.40	\$0.00	\$2.91	\$0.00	\$0.00	\$0.00	\$37.69	\$50.02
7th 6 months	75.00	\$26.41	\$7.17	\$3.31	\$0.40	\$0.00	\$3.11	\$0.00	\$0.00	\$0.00	\$40.41	\$53.61
8th 6 months	80.00	\$28.18	\$7.17	\$3.35	\$0.40	\$0.00	\$3.32	\$0.00	\$0.00	\$0.00	\$42.42	\$56.50

Special Calculation Note : Apprentice pay based on percentage of above appropriate classification.

Prevailing Wage Rate Skilled Crafts

Name of Union: Pipefitter Local 120

Change # : LCN01-2020fbLoc120

Craft : Pipefitter Effective Date : 05/14/2020 Last Posted : 05/14/2020

	BHR		Fringe Benefit Payments					Irrevocable Fund		Total PWR	Overtime Rate	
			H&W	Pension	App Tr.	Vac.	Annuity	Other	LECET (*)			MISC (*)
Classification												
Pipefitter	\$40.22		\$11.90	\$10.70	\$1.02	\$0.00	\$3.00	\$0.30	\$0.00	\$0.00	\$67.14	\$87.25
Apprentice	Percent											
1st year	49.18	\$19.78	\$5.35	\$0.00	\$1.02	\$0.00	\$0.00	\$0.00	\$0.00	\$0.00	\$26.15	\$36.04
2nd year	51.34	\$20.65	\$11.30	\$6.10	\$1.02	\$0.00	\$0.00	\$0.30	\$0.00	\$0.00	\$39.37	\$49.69
3rd year	59.57	\$23.96	\$11.30	\$6.10	\$1.02	\$0.00	\$0.00	\$0.30	\$0.00	\$0.00	\$42.68	\$54.66
4th year	71.06	\$28.58	\$11.30	\$6.10	\$1.02	\$0.00	\$0.00	\$0.30	\$0.00	\$0.00	\$47.30	\$61.59
5th year	79.29	\$31.89	\$11.30	\$6.10	\$1.02	\$0.00	\$0.00	\$0.30	\$0.00	\$0.00	\$50.61	\$66.56

Special Calculation Note : OTHER IS :SUPPLEMENTAL UNEMPLOYMENT BENEFITS

Ratio :

- 1 Journeymen to 1 Apprentice per project
- 2-4 Journeymen to 2 Apprentices per project
- 5-7 Journeymen to 3 Apprentices per project

3 to 1 on jobs with 9 or more journeymen

Jurisdiction (* denotes special jurisdictional note) :

ASHTABULA, CUYAHOGA, GEAUGA, LAKE, MEDINA*, SUMMIT*

Special Jurisdictional Note : Summit County - North of State Route 303 including work within the corporate limits of the City of Hudson, that portion of Medina County North of State Route 18 and Smith Road and including work within the corporate limits of the City of Medina.

Details :

Under pipefitter duties shall include - steam and hot water heating boilers and related controls such as automatic feedwater and low water cut-offs, safety relief valves and gas trains; steam regulators, traps, steam valves, steam heaters, steam and hot water heating coils; feedwater lines to boilers, condensate pumps, condensate tanks and related piping to boilers, expansion tanks and controls on hot water heating systems; refrigeration and air conditioning systems that are separate from one another and are connected through piping; install, calibrate and maintain pneumatic temperature controls and piping for heating and cooling devices; piping, pumps and controls on the fluent water system in water treatment plants; hose cabinets and automatic fire sprinkler systems; underground water supply piping and devices; all fire stopping of piping systems; to operate a pipe cutting machine, to thread pipe by machine or hand dies; to do oxyacetylene and electric welding on iron and steel pipes when required; to perform other tasks when assigned.

Prevailing Wage Rate Skilled Crafts

Name of Union: Pipefitter Local 120 Mechanical Equipment

Change # : LCN01-2020fbLoc120

Craft : Pipefitter Effective Date : 05/14/2020 Last Posted : 05/14/2020

	BHR		Fringe Benefit Payments					Irrevocable Fund		Total PWR	Overtime Rate	
			H&W	Pension	App Tr.	Vac.	Annuity	Other	LECET (*)			MISC (*)
Classification												
Pipefitter Mechanical Equipment Service A-2	\$30.30		\$11.90	\$10.70	\$1.02	\$0.00	\$3.00	\$0.30	\$0.00	\$0.00	\$57.22	\$72.37
Pipefitter Mechanical Equipment Service A-1	\$27.00		\$11.90	\$10.70	\$1.02	\$0.00	\$3.00	\$0.30	\$0.00	\$0.00	\$53.92	\$67.42
Intermediate Journeymen												
Serviceman 1	\$21.52		\$11.20	\$3.80	\$0.94	\$0.00	\$1.55	\$0.30	\$0.00	\$0.00	\$39.31	\$50.07
Serviceman 2	\$24.15		\$11.20	\$3.80	\$0.94	\$0.00	\$1.55	\$0.30	\$0.00	\$0.00	\$41.94	\$54.01
Serviceman 3	\$27.11		\$11.20	\$3.80	\$0.94	\$0.00	\$1.55	\$0.30	\$0.00	\$0.00	\$44.90	\$58.45
Serviceman 4	\$30.32		\$11.20	\$3.80	\$0.94	\$0.00	\$1.55	\$0.30	\$0.00	\$0.00	\$48.11	\$63.27
MES Trainees	Percent											
1st year	57.72	\$17.49	\$5.65	\$0.00	\$1.02	\$0.00	\$0.00	\$0.00	\$0.00	\$0.00	\$24.16	\$32.90
2nd year	62.04	\$18.80	\$5.65	\$3.80	\$1.02	\$0.00	\$1.50	\$0.00	\$0.00	\$0.00	\$30.77	\$40.17
3rd year	68.61	\$20.79	\$5.65	\$3.80	\$1.02	\$0.00	\$1.50	\$0.00	\$0.00	\$0.00	\$32.76	\$43.15
4th year	79.50	\$24.09	\$5.65	\$3.80	\$1.02	\$0.00	\$1.50	\$0.00	\$0.00	\$0.00	\$36.06	\$48.10
5th year	86.07	\$26.08	\$5.65	\$3.80	\$1.02	\$0.00	\$1.50	\$0.00	\$0.00	\$0.00	\$38.05	\$51.09

Special Calculation Note : OTHER IS :SUPPLEMENTAL UNEMPLOYMENT BENEFITS

Ratio :

3 Journeymen to 1 Apprentice
2 Intermediate Servicemen to 1 Serviceman
Trainee per shop

Jurisdiction (* denotes special jurisdictional note):

ASHTABULA, CUYAHOGA, GEAUGA, LAKE,
MEDINA*, SUMMIT*

Special Jurisdictional Note : Summit County - North of State Route 303 including work within the corporate limits of the City of Hudson, that portion of Medina County North of Route 18 and Smith Road and including work within the corporate limits of the City of Medina.

Details :

Work scope but not limited to: Mechanical Service and Maintenance work normally performed by contractors, either by contracts or emergency call basis, who are equipped to handle all work relating to evacuation, charging, start-up, inspection, operating, maintenance and service call necessary to keep mechanical system and controls of a refrigeration, air conditioning, heating and/or ventilation or any other newly installed, remodeled, revamped or redesigned mechanical system in operational order; all fire stopping and piping systems. Shall include but not limited to all maintaining, cleaning, adjusting, repairing, overhauling, starting and balancing of any system or component part thereof, regardless of size or location, including all other service and maintenance work assigned to the employer by the customer. Shall also be allowed to do the following installation work: All residential humidifiers and dehumidifiers, all window type units, all residential heating and cooling systems, excluding steam and hot water, and when a building is not new construction, all refrigeration systems up to 20 tons, split air conditioning systems up to 50 tons, and package or self-contained air conditioning units up to 50 tons.

(remodel/renovation of existing facilities only), banks, bars, restaurants, churches, bowling alleys, movie theaters, hotels/motels not exceeding four floors and nursing homes, assisted living facilities and retirement homes not exceeding 450 fixture units counting floor drains.

Prevailing Wage Rate Skilled Crafts

Name of Union: Plumber Local 219 Mechanical Equipment Service (HVAC)

Change # : LCN01-2020fbLoc219

Craft : Plumber Effective Date : 07/09/2020 Last Posted : 07/09/2020

	BHR		Fringe Benefit Payments					Irrevocable Fund		Total PWR	Overtime Rate	
			H&W	Pension	App Tr.	Vac.	Annuity	Other	LECET (*)			MISC (*)
Classification												
Plumber Journeyman	\$34.62		\$8.21	\$5.07	\$2.37	\$0.00	\$1.95	\$0.00	\$0.00	\$0.00	\$52.22	\$69.53
Plumber Service Journeyman 1st Year	\$31.12		\$8.21	\$5.07	\$2.37	\$0.00	\$1.95	\$0.00	\$0.00	\$0.00	\$48.72	\$64.28
Plumber Service Journeyman 2nd Year	\$32.28		\$8.21	\$5.07	\$2.37	\$0.00	\$1.95	\$0.00	\$0.00	\$0.00	\$49.88	\$66.02
Plumber Service Journeyman 3rd Year	\$33.45		\$8.21	\$5.07	\$2.37	\$0.00	\$1.95	\$0.00	\$0.00	\$0.00	\$51.05	\$67.78
Plumber Service Journeyman 4th Year	\$31.12		\$8.21	\$5.07	\$2.37	\$0.00	\$1.95	\$0.00	\$0.00	\$0.00	\$48.72	\$64.28
Apprentice	Percent											
1st 12 months	44.95	\$15.56	\$8.21	\$0.00	\$2.37	\$0.00	\$0.00	\$0.00	\$0.00	\$0.00	\$26.14	\$33.92
2nd 12 months	53.92	\$18.67	\$8.21	\$5.07	\$2.37	\$0.00	\$1.95	\$0.00	\$0.00	\$0.00	\$36.27	\$45.60
3rd 12 months	62.92	\$21.78	\$8.21	\$5.07	\$2.37	\$0.00	\$1.95	\$0.00	\$0.00	\$0.00	\$39.38	\$50.27
4th 12 months	71.92	\$24.90	\$8.21	\$5.07	\$2.37	\$0.00	\$1.95	\$0.00	\$0.00	\$0.00	\$42.50	\$54.95
5th 12 months	80.92	\$28.01	\$8.21	\$5.07	\$2.37	\$0.00	\$1.95	\$0.00	\$0.00	\$0.00	\$45.61	\$59.62

Special Calculation Note :

Ratio :

Journeymen to 1 Apprentice
 Journeymen to 2 Apprentice
 Journeymen to 3 Apprentice

Jurisdiction (* denotes special jurisdictional note) :

MEDINA*, PORTAGE, SUMMIT*

Special Jurisdictional Note : Summit County: South of Route 303, except for the corporate limits of Hudson, Ohio, which shall be considered neutral territory, dependent on the contractor doing work from the jurisdiction of Local Unions #55 & #120 & #219. Medina County: Route 18 from the eastern edge of Medina County west to eastern corporate limits of the City of Medina and on the county Road from the west corporate limits of the City of Medina, running due west to and through the community of Risley to the western edge of Medina County. All territory south of this line is the jurisdiction of Local #219. Work within the corporate limits of the City of Medina shall be neutral territory, dependent on the contractor doing the work from the jurisdiction of Locals #55, #120 & #219.

Details :

Service and maintenance shall include, all the maintaining, cleaning, adjusting, repairing, altering, overhauling, dismantling, reconditioning, replacing, modifying, renovating, evacuating, charging, inspecting, operating, starting, calibrating, and balancing of any system or component part thereof. Work performed by Service Journeymen & apprentices shall include: all heating repairs & emergency service up to a capacity of 2,000,000 BTU input. Air conditioning repairs and

Prevailing Wage Rate Skilled Crafts

Name of Union: Plumber Pipefitter Local 219

Change # : LCN01-2020fbLoc219

Craft : Plumbers Effective Date : 07/09/2020 Last Posted : 07/09/2020

	BHR		Fringe Benefit Payments					Irrevocable Fund		Total PWR	Overtime Rate	
			H&W	Pension	App Tr.	Vac.	Annuity	Other	LECET (*)			MISC (*)
Classification												
Plumber Pipefitter	\$39.32		\$8.31	\$11.75	\$2.45	\$0.00	\$4.00	\$0.00	\$0.00	\$0.00	\$65.83	\$85.49
Apprentice	Percent											
1st 6 months	40.00	\$15.73	\$8.31	\$0.00	\$2.45	\$0.00	\$1.50	\$0.00	\$0.00	\$0.00	\$27.99	\$35.85
2nd 6 months	45.00	\$17.69	\$8.31	\$0.00	\$2.45	\$0.00	\$1.50	\$0.00	\$0.00	\$0.00	\$29.95	\$38.80
3rd 6 months	50.00	\$19.66	\$8.31	\$11.75	\$2.45	\$0.00	\$4.00	\$0.00	\$0.00	\$0.00	\$46.17	\$56.00
4th 6 months	55.00	\$21.63	\$8.31	\$11.75	\$2.45	\$0.00	\$4.00	\$0.00	\$0.00	\$0.00	\$48.14	\$58.95
5th 6 months	60.00	\$23.59	\$8.31	\$11.75	\$2.45	\$0.00	\$4.00	\$0.00	\$0.00	\$0.00	\$50.10	\$61.90
6th 6 months	65.00	\$25.56	\$8.31	\$11.75	\$2.45	\$0.00	\$4.00	\$0.00	\$0.00	\$0.00	\$52.07	\$64.85
7th 6 months	70.00	\$27.52	\$8.31	\$11.75	\$2.45	\$0.00	\$4.00	\$0.00	\$0.00	\$0.00	\$54.03	\$67.80
8th 6 months	75.00	\$29.49	\$8.31	\$11.75	\$2.45	\$0.00	\$4.00	\$0.00	\$0.00	\$0.00	\$56.00	\$70.75
9th 6 months	80.00	\$31.46	\$8.31	\$11.75	\$2.45	\$0.00	\$4.00	\$0.00	\$0.00	\$0.00	\$57.97	\$73.69
10th 6 months	85.00	\$33.42	\$8.31	\$11.75	\$2.45	\$0.00	\$4.00	\$0.00	\$0.00	\$0.00	\$59.93	\$76.64

Special Calculation Note :

Ratio :
Apprentice for 2 Journeyman.

Jurisdiction (* denotes special jurisdictional note)
MEDINA*, PORTAGE, SUMMIT*

Special Jurisdictional Note : Summit County: South of Route 303, except for the corporate limits of Hudson, Ohio, which shall be considered neutral territory, dependent on the contractor doing work from the jurisdiction of Local Unions #55 & #120 & #219.

Medina County: Route 18 from the eastern edge of Medina County west to eastern corporate limits of the City of Medina and on the county Road from the west corporate limits of the City of Medina, running due west to and through the community of Risley to the western edge of Medina County. All territory south of this line is the jurisdiction of Local #219. Work within the corporate limits of the City of Medina shall be neutral territory, dependent on the contractor doing the work from the jurisdiction of Locals #55, #120 & #219.

Details :

Prevailing Wage Rate Skilled Crafts

Name of Union: Plumber Local 55

Change # : LCR02-2020fbLoc55Plum

Craft : Plumber Effective Date : 08/12/2020 Last Posted : 08/12/2020

	BHR		Fringe Benefit Payments					Irrevocable Fund		Total PWR	Overtime Rate	
			H&W	Pension	App Tr.	Vac.	Annuity	Other	LECET (*)			MISC (*)
Classification												
Plumber	\$37.07		\$9.75	\$12.63	\$1.23	\$0.00	\$4.10	\$0.01	\$0.00	\$0.00	\$64.79	\$83.32
Yard Piping	\$24.36		\$6.94	\$2.91	\$0.69	\$0.00	\$1.59	\$0.30	\$0.00	\$0.00	\$36.79	\$48.97
Shopman (When in the field)	\$20.35		\$7.43	\$7.30	\$0.10	\$0.00	\$2.14	\$0.00	\$0.00	\$0.00	\$37.32	\$47.50
Shopman (when in the field) After 5/1/10	\$14.01		\$6.46	\$1.80	\$0.10	\$0.00	\$1.20	\$0.00	\$0.00	\$0.00	\$23.57	\$30.58
Plumber Light Commercial Journeymen	\$25.16		\$7.03	\$4.08	\$0.69	\$0.00	\$1.78	\$0.01	\$0.00	\$0.00	\$38.75	\$51.33
Apprentice Light Commercial Trainee												
0-3 Months	\$12.59		\$0.00	\$0.00	\$0.50	\$0.00	\$0.00	\$0.00	\$0.00	\$0.00	\$13.09	\$19.38
4-6 Months	\$13.39		\$2.52	\$0.00	\$0.46	\$0.00	\$0.00	\$0.00	\$0.00	\$0.00	\$16.37	\$23.07
7-12 Months	\$13.46		\$3.12	\$1.20	\$0.63	\$0.00	\$0.26	\$0.00	\$0.00	\$0.00	\$18.67	\$25.40
2dn Year	\$14.64		\$3.14	\$1.28	\$0.65	\$0.00	\$0.27	\$0.00	\$0.00	\$0.00	\$19.98	\$27.30
3rd Year	\$15.83		\$3.14	\$1.35	\$0.68	\$0.00	\$0.29	\$0.00	\$0.00	\$0.00	\$21.29	\$29.21
Apprentice Initiated AFTER 5/1/10	Percent											
1-6 Months	45.84	\$16.99	\$5.79	\$1.44	\$0.95	\$0.00	\$0.36	\$0.00	\$0.00	\$0.00	\$25.53	\$34.03
7-12 Months	52.51	\$19.47	\$5.87	\$1.79	\$1.00	\$0.00	\$0.66	\$0.01	\$0.00	\$0.00	\$28.80	\$38.53
2nd year 1-6	55.62	\$20.62	\$6.49	\$2.35	\$1.05	\$0.00	\$1.56	\$0.01	\$0.00	\$0.00	\$32.08	\$42.39
2nd year 7-12	56.98	\$21.12	\$6.54	\$4.50	\$1.05	\$0.00	\$2.13	\$0.01	\$0.00	\$0.00	\$35.35	\$45.91
3rd year 1-6	64.28	\$23.83	\$6.93	\$4.60	\$1.05	\$0.00	\$2.20	\$0.01	\$0.00	\$0.00	\$38.62	\$50.53
3rd year 7-12	68.96	\$25.56	\$7.03	\$5.58	\$1.05	\$0.00	\$2.67	\$0.01	\$0.00	\$0.00	\$41.90	\$54.69
4th year	75.31	\$27.92	\$7.14	\$6.17	\$1.05	\$0.00	\$2.88	\$0.01	\$0.00	\$0.00	\$45.17	\$59.13
5th year	81.73	\$30.30	\$7.25	\$6.76	\$1.05	\$0.00	\$3.08	\$0.01	\$0.00	\$0.00	\$48.45	\$63.60

Special Calculation Note : OTHER IS: SUPPLEMENTAL UNEMPLOYMENT

Ratio :

1 Journeymen 1 Apprentice

Light Commercial Ratio

1-2 Journeymen to 1 Trainee

3 Journeymen to 2 Trainees

4-5 Journeymen to 3 Trainees

6-8 Journeymen to 4 Trainees

9-10 Journeymen to 5 Trainees

11-13 Journeymen to 6 Trainees

Jurisdiction (* denotes special jurisdictional note) :

ASHTABULA, CUYAHOGA, GEAUGA, LAKE,
MEDINA *, SUMMIT*

Special Jurisdictional Note : Summit County - North of State Route 303 including work within the corporate limits of the City of Hudson, that portion of Medina County North of Route 18 and Smith Road and the corporate limits of the City of Medina.

Details :

The Plumber Shopman will have charge of the Employer's shop and warehouse containing plumbing and heating supplies and equipment, and perform such duties as are customarily required by a Plumber or a Plumber's Shopman, including casual delivery of tools and equipment necessary for installation of Plumbing and Heating facilities.

Prevailing Wage Rate Skilled Crafts

Name of Union: Roofer Local 88

Change # : LCN01-2020fbLoc88

Craft : Roofer Effective Date : 06/04/2020 Last Posted : 06/04/2020

	BHR		Fringe Benefit Payments					Irrevocable Fund		Total PWR	Overtime Rate	
			H&W	Pension	App Tr.	Vac.	Annuity	Other	LECET (*)			MISC (*)
Classification												
Roofer	\$27.00		\$8.90	\$8.95	\$0.40	\$0.00	\$1.25	\$0.15	\$0.00	\$0.00	\$46.65	\$60.15
HELPER												
Helper -500 Hrs. 1st 6 months	\$15.12		\$2.25	\$0.00	\$0.40	\$0.00	\$1.25	\$0.15	\$0.00	\$0.00	\$19.17	\$26.73
Helper -500 Hrs. 2nd 6 months	\$16.74		\$8.90	\$8.95	\$0.40	\$0.00	\$1.25	\$0.15	\$0.00	\$0.00	\$36.39	\$44.76
2nd year Helper	\$18.36		\$8.90	\$8.95	\$0.40	\$0.00	\$1.25	\$0.15	\$0.00	\$0.00	\$38.01	\$47.19
3rd year Helper	\$19.98		\$8.90	\$8.95	\$0.40	\$0.00	\$1.25	\$0.15	\$0.00	\$0.00	\$39.63	\$49.62
4th year Helper	\$21.60		\$8.90	\$8.95	\$0.40	\$0.00	\$1.25	\$0.15	\$0.00	\$0.00	\$41.25	\$52.05
5th year Helper	\$23.22		\$8.90	\$8.95	\$0.40	\$0.00	\$1.25	\$0.15	\$0.00	\$0.00	\$42.87	\$54.48
5th year Helper	\$24.84		\$8.90	\$8.95	\$0.40	\$0.00	\$1.25	\$0.15	\$0.00	\$0.00	\$44.49	\$56.91
Apprentice	Percent											
1st 6 months w/500 hrs	56.00	\$15.12	\$8.90	\$8.95	\$0.40	\$0.00	\$1.25	\$0.15	\$0.00	\$0.00	\$34.77	\$42.33
2nd 6 months w/500 hrs	62.00	\$16.74	\$8.90	\$8.95	\$0.40	\$0.00	\$1.25	\$0.15	\$0.00	\$0.00	\$36.39	\$44.76
3rd 6 months w/500 hrs	68.00	\$18.36	\$8.90	\$8.95	\$0.40	\$0.00	\$1.25	\$0.15	\$0.00	\$0.00	\$38.01	\$47.19
4th 6 months w/500 hrs	74.00	\$19.98	\$8.90	\$8.95	\$0.40	\$0.00	\$1.25	\$0.15	\$0.00	\$0.00	\$39.63	\$49.62
5th 6 months w/500 hrs	80.00	\$21.60	\$8.90	\$8.95	\$0.40	\$0.00	\$1.25	\$0.15	\$0.00	\$0.00	\$41.25	\$52.05
6th 6 months w/500 hrs	86.00	\$23.22	\$8.90	\$8.95	\$0.40	\$0.00	\$1.25	\$0.15	\$0.00	\$0.00	\$42.87	\$54.48

months w/500 hrs												
8th 6 months w/500 hrs	100.00	\$27.00	\$8.90	\$8.95	\$0.40	\$0.00	\$1.25	\$0.15	\$0.00	\$0.00	\$46.65	\$60.15

Special Calculation Note : Roofers working in any form of coal tar pitch, whether hot or cold, installing and/or removing will be paid \$.25 more per hour. Other \$.15 is for C.I.D.B.

Ratio : No helper shall be used on any one job unless 1 Journeymen, and 1 Apprentices are working on said job .One (1) Journeymen to One (1) Apprentice to One (1) Helper

Jurisdiction (* denotes special jurisdictional note)
 ASHLAND, CARROLL, COSHOCTON, CRAWFORD, HOLMES, HURON, LORAIN*, MEDINA, PORTAGE, RICHLAND, STARK, SUMMIT, TUSCARAWAS, WAYNE

Special Jurisdictional Note : In Lorain County (South of the Turnpike)

Details :

Prevailing Wage Rate Skilled Crafts

Name of Union: Sheet Metal Local 33 (Akron)

Change # : LCN03-2020fbLoc33Akron

Craft : Sheet Metal Worker Effective Date : 09/23/2020 Last Posted : 09/23/2020

	BHR		Fringe Benefit Payments					Irrevocable Fund		Total PWR	Overtime Rate	
			H&W	Pension	App Tr.	Vac.	Annuity	Other	LECET (*)			MISC (*)
Classification												
Sheet Metal Worker	\$32.12		\$8.50	\$12.89	\$1.21	\$0.00	\$6.60	\$0.00	\$0.00	\$0.00	\$61.32	\$77.38
Industrial Door	\$23.08		\$7.38	\$5.33	\$0.17	\$0.00	\$1.87	\$0.00	\$0.00	\$0.00	\$37.83	\$49.37
Apprentice Helper Trainee												
1st 60 Days Probationary Period	\$11.63		\$0.00	\$0.00	\$0.00	\$0.00	\$0.00	\$0.00	\$0.00	\$0.00	\$11.63	\$17.44
61 days-12 Months	\$12.97		\$7.38	\$1.84	\$0.17	\$0.00	\$1.25	\$0.00	\$0.00	\$0.00	\$23.61	\$30.10
2nd Year	\$15.20		\$7.38	\$1.84	\$0.17	\$0.00	\$1.40	\$0.00	\$0.00	\$0.00	\$25.99	\$33.59
3rd Year	\$16.32		\$7.38	\$1.84	\$0.17	\$0.00	\$1.48	\$0.00	\$0.00	\$0.00	\$27.19	\$35.35
4th Year	\$17.89		\$7.38	\$1.84	\$0.17	\$0.00	\$1.58	\$0.00	\$0.00	\$0.00	\$28.86	\$37.81
5th Year	\$19.23		\$7.38	\$1.84	\$0.17	\$0.00	\$1.67	\$0.00	\$0.00	\$0.00	\$30.29	\$39.91
Apprentice	Percent											
Apprentice												
1st year	45.00	\$14.45	\$8.50	\$3.47	\$0.17	\$0.00	\$0.00	\$0.00	\$0.00	\$0.00	\$26.59	\$33.82
2nd year	50.00	\$16.06	\$8.50	\$4.62	\$1.21	\$0.00	\$3.30	\$0.00	\$0.00	\$0.00	\$33.69	\$41.72
3rd year	55.00	\$17.67	\$8.50	\$5.00	\$1.21	\$0.00	\$3.30	\$0.00	\$0.00	\$0.00	\$35.68	\$44.51
4th year	65.00	\$20.88	\$8.50	\$5.77	\$1.21	\$0.00	\$3.30	\$0.00	\$0.00	\$0.00	\$39.66	\$50.10
5th year	80.00	\$25.70	\$8.50	\$6.93	\$1.21	\$0.00	\$3.30	\$0.00	\$0.00	\$0.00	\$45.64	\$58.48

Special Calculation Note : No special calculations for this skilled craft wage rate are required at this time.

Ratio :

- 1 Journeymen to 1 Apprentice
- 2 Journeymen to 1 Apprentice
- 3 Journeymen to 2 Apprentice
- 4 Journeymen to 2 Apprentice
- 5-7 Journeymen to 3 Apprentice

Jurisdiction (* denotes special jurisdictional note) :

- ASHLAND, CARROLL, COSHOCTON,
- CRAWFORD, HOLMES, MEDINA, PORTAGE,
- RICHLAND, STARK, SUMMIT, TUSCARAWAS,
- WAYNE

8-10 Journeymen to 4 Apprentice
11-13 Journeymen to 5 Apprentice
14, 15 Journeymen to 6 Apprentice
and maintaining a three to one apprentice ratio
thereafter.

Special Jurisdictional Note :

Details :

Scope of Work: This Agreement covers the rates of pay and conditions of employment of all employees of the Employer engaged in, but not limited to, the a) manufacture, fabrication, assembling, handling, erection, installation, dismantling, conditioning, adjustment, alteration, repairing and servicing of all ferrous or non-ferrous metal work and all other materials used in lieu thereof and of all HVAC systems, air-veyor systems, exhaust systems, and air handling systems regardless of material used, including the setting of all equipment and all reinforcements in connection therewith; (b) all lagging over insulation and all duct-lining; (c) testing, servicing, and balancing of all air-handling equipment and duct work; (d) the preparation of all shop and field sketches, whether manually drawn or computer assisted, used in fabrication and erection, including those taken from original architectural and engineering drawings or sketches, and (e) metal roofing; and (f) all other work included in the jurisdictional claims of Sheet Metal Worker's International Association.

Industrial Door-Installation and service of overhead doors roll up doors, docks and dock leveling.

Prevailing Wage Rate Skilled Crafts

Name of Union: Sprinkler Fitter Local 669

Change # : LCN02-2020fbLoc669

Craft : Sprinkler Fitter Effective Date : 01/01/2021 Last Posted : 12/22/2020

	BHR		Fringe Benefit Payments						Irrevocable Fund		Total PWR	Overtime Rate
			H&W	Pension	App Tr.	Vac.	Annuity	Other	LECET (*)	MISC (*)		
Classification												
Sprinkler Fitter	\$40.40		\$10.55	\$7.00	\$0.52	\$0.00	\$5.12	\$0.10	\$0.00	\$0.00	\$63.69	\$83.89
Apprentice Indentured after April 1, 2013	Percent											
CLASS 1	45.00	\$18.18	\$7.75	\$0.00	\$0.52	\$0.00	\$0.00	\$0.10	\$0.00	\$0.00	\$26.55	\$35.64
CLASS 2	50.00	\$20.20	\$7.75	\$0.00	\$0.52	\$0.00	\$0.00	\$0.10	\$0.00	\$0.00	\$28.57	\$38.67
CLASS 3	54.38	\$21.97	\$10.55	\$7.00	\$0.52	\$0.00	\$1.15	\$0.10	\$0.00	\$0.00	\$41.29	\$52.27
CLASS 4	59.38	\$23.99	\$10.55	\$7.00	\$0.52	\$0.00	\$1.15	\$0.10	\$0.00	\$0.00	\$43.31	\$55.30
CLASS 5	64.38	\$26.01	\$10.55	\$7.00	\$0.52	\$0.00	\$1.40	\$0.10	\$0.00	\$0.00	\$45.58	\$58.58
CLASS 6	69.38	\$28.03	\$10.55	\$7.00	\$0.52	\$0.00	\$1.40	\$0.10	\$0.00	\$0.00	\$47.60	\$61.61
CLASS 7	74.38	\$30.05	\$10.55	\$7.00	\$0.52	\$0.00	\$1.40	\$0.10	\$0.00	\$0.00	\$49.62	\$64.64
CLASS 8	79.38	\$32.07	\$10.55	\$7.00	\$0.52	\$0.00	\$1.40	\$0.10	\$0.00	\$0.00	\$51.64	\$67.67
CLASS 9	84.38	\$34.09	\$10.55	\$7.00	\$0.52	\$0.00	\$1.40	\$0.10	\$0.00	\$0.00	\$53.66	\$70.70
CLASS 10	89.38	\$36.11	\$10.55	\$7.00	\$0.52	\$0.00	\$1.40	\$0.10	\$0.00	\$0.00	\$55.68	\$73.73

Special Calculation Note : \$0.10 for Other is National Fire Sprinkler Association

Ratio :

1 Journeyman to 1 Apprentice

Jurisdiction (* denotes special jurisdictional note) :

ADAMS, ALLEN, ASHLAND, ASHTABULA, ATHENS, AUGLAIZE, BELMONT, BROWN, BUTLER, CARROLL, CHAMPAIGN, CLARK, CLERMONT, CLINTON, COLUMBIANA, COSHOCTON, CRAWFORD, DARKE, DEFIANCE, DELAWARE, ERIE, FAIRFIELD, FAYETTE, FRANKLIN, FULTON, GALLIA, GREENE, GUERNSEY, HAMILTON, HANCOCK, HARDIN, HARRISON, HENRY, HIGHLAND, HOCKING, HOLMES, HURON, JACKSON, JEFFERSON, KNOX, LAWRENCE, LICKING, LOGAN, LUCAS, MADISON, MAHONING,

MARION, MEDINA, MEIGS, MERCER, MIAMI,
MONROE, MONTGOMERY, MORGAN,
MORROW, MUSKINGUM, NOBLE, OTTAWA,
PAULDING, PERRY, PICKAWAY, PIKE,
PORTAGE, PREBLE, PUTNAM, RICHLAND,
ROSS, SANDUSKY, SCIOTO, SENECA, SHELBY,
STARK, SUMMIT, TRUMBULL, TUSCARAWAS,
UNION, VAN WERT, VINTON, WARREN,
WASHINGTON, WAYNE, WILLIAMS, WOOD,
WYANDOT

Special Jurisdictional Note :

Details :

Sprinkler Fitter work shall consist of the installation, dismantling, maintenance, repairs, adjustments, and corrections of all fire protection and fire control systems including the unloading, handling by hand, power equipment and installation of all piping or tubing, appurtenances and equipment pertaining thereto, including both overhead and underground water mains, fire hydrants and hydrant mains, standpipes and hose connections to sprinkler systems used in connection with sprinkler and alarm systems. Also all tanks and pumps connected thereto, also included shall be CO-2 and Cardox Systems, Dry Chemical Systems, Foam Systems and all other fire protection systems.

Prevailing Wage Rate Skilled Crafts

**Name of Union: Truck Driver Bldg & HevHwy Class 1
Locals 20,40,92,92b,100,175,284,438,377,637,908,957**

Change # : OCRO1-2019fbBldgHevHwy

Craft : Truck Driver Effective Date : 09/11/2019 Last Posted : 09/11/2019

	BHR		Fringe Benefit Payments					Irrevocable Fund		Total PWR	Overtime Rate	
			H&W	Pension	App Tr.	Vac.	Annuity	Other	LECET (*)			MISC (*)
Classification												
Truck Driver CLASS 1 4 wheel service, dump, and batch trucks, Oil Distributor - Asphalt Distributor-Tandems	\$28.04		\$7.00	\$7.90	\$0.20	\$0.00	\$0.00	\$0.00	\$0.00	\$0.00	\$43.14	\$57.16
Apprentice	Percent											
First 6 months	80.00	\$22.43	\$7.00	\$7.90	\$0.20	\$0.00	\$0.00	\$0.00	\$0.00	\$0.00	\$37.53	\$48.75
7-12 months	85.00	\$23.83	\$7.00	\$7.90	\$0.20	\$0.00	\$0.00	\$0.00	\$0.00	\$0.00	\$38.93	\$50.85
13-18 months	90.00	\$25.24	\$7.00	\$7.90	\$0.20	\$0.00	\$0.00	\$0.00	\$0.00	\$0.00	\$40.34	\$52.95
19-24 months	95.00	\$26.64	\$7.00	\$7.90	\$0.20	\$0.00	\$0.00	\$0.00	\$0.00	\$0.00	\$41.74	\$55.06
25-30 months	100.00	\$28.04	\$7.00	\$7.90	\$0.20	\$0.00	\$0.00	\$0.00	\$0.00	\$0.00	\$43.14	\$57.16

Special Calculation Note : No special calculations for this skilled craft wage rate are required at this time.

Ratio :

3 Journeymen to 1 Apprentice

Jurisdiction (* denotes special jurisdictional note) :

ADAMS, ALLEN, ASHLAND,
ASHTABULA, ATHENS, AUGLAIZE,
BELMONT, BROWN, BUTLER,
CARROLL, CHAMPAIGN, CLARK,
CLERMONT, CLINTON, COLUMBIANA,
COSHOCOTON, CRAWFORD, DARKE,
DEFIANCE, DELAWARE, ERIE,
FAIRFIELD, FAYETTE, FRANKLIN,
FULTON, GALLIA, GREENE, GUERNSEY,
HAMILTON, HANCOCK, HARDIN,
HARRISON, HENRY, HIGHLAND,
HOCKING, HOLMES, HURON, JACKSON,
JEFFERSON, KNOX, LAWRENCE,
LICKING, LOGAN, LORAIN, LUCAS,
MADISON, MAHONING, MARION,
MEDINA, MEIGS, MERCER, MIAMI,
MONROE, MONTGOMERY, MORGAN,
MORROW, MUSKINGUM, NOBLE,
OTTAWA, PAULDING, PERRY,
PICKAWAY, PIKE, PORTAGE, PREBLE,
PUTNAM, RICHLAND, ROSS,
SANDUSKY, SCIOTO, SENECA, SHELBY,
STARK, SUMMIT, TRUMBULL,
TUSCARAWAS, UNION, VAN WERT,
VINTON, WARREN, WASHINGTON,
WAYNE, WILLIAMS, WOOD, WYANDOT

Special Jurisdictional Note :

Details :

** Asphalt - Oil spray bar man when operating from cab shall receive \$0.20 cents per hour above their Basic Hourly Rate.

Prevailing Wage Rate Skilled Crafts

Name of Union: Truck Driver Bldg & HevHwy Class 2
Locals 20,40,92,92b,100,175,284,438,377,637,908,957

Change # : LCRO1-2019-fbBldgHevHwy

Craft : Truck Driver Effective Date : 10/16/2019 Last Posted : 10/16/2019

	BHR		Fringe Benefit Payments					Irrevocable Fund		Total PWR	
			H&W	Pension	App Tr.	Vac.	Annuity	Other	LECET (*)		MISC (*)
Classification											
Truck Driver CLASS 2 Tractor Trailer-Semi Tractor Trucks-Pole Trailers-Ready Mix Trucks-Fuel Trucks- Asphalt-Oil Spray bar men- 5 Axle & Over - Belly Dumps-End Dumps-Articulated Dump Trucks- Low boys-Heavy duty Equipment(irrespective of load carried) when used exclusively for transportation-Truck Mechanics (when needed)	\$28.46		\$7.00	\$7.90	\$0.20	\$0.00	\$0.00	\$0.00	\$0.00	\$0.00	\$43.56
Apprentice	Percent										
First 6 months	80.00	\$22.77	\$7.00	\$7.90	\$0.20	\$0.00	\$0.00	\$0.00	\$0.00	\$0.00	\$37.87
7-12 months	85.00	\$24.19	\$7.00	\$7.90	\$0.20	\$0.00	\$0.00	\$0.00	\$0.00	\$0.00	\$39.29
13-18 months	90.00	\$25.61	\$7.00	\$7.90	\$0.20	\$0.00	\$0.00	\$0.00	\$0.00	\$0.00	\$40.71
19-24 months	95.00	\$27.04	\$7.00	\$7.90	\$0.20	\$0.00	\$0.00	\$0.00	\$0.00	\$0.00	\$42.14
25-30 months	100.00	\$28.46	\$7.00	\$7.90	\$0.20	\$0.00	\$0.00	\$0.00	\$0.00	\$0.00	\$43.56

Special Calculation Note : No special calculations for this skilled craft wage rate are required at this time.

Ratio :

3 Journeymen to 1 Apprentice

Jurisdiction (* denotes special jurisdictional note) :

ADAMS, ALLEN, ASHLAND,
ASHTABULA, ATHENS, AUGLAIZE,
BELMONT, BROWN, BUTLER,
CARROLL, CHAMPAIGN, CLARK,
CLERMONT, CLINTON, COLUMBIANA,
COSHOCTON, CRAWFORD, DARKE,
DEFIANCE, DELAWARE, ERIE,
FAIRFIELD, FAYETTE, FRANKLIN,
FULTON, GALLIA, GREENE, GUERNSEY,
HAMILTON, HANCOCK, HARDIN,
HARRISON, HENRY, HIGHLAND,
HOCKING, HOLMES, HURON,
JACKSON, JEFFERSON, KNOX,
LAWRENCE, LICKING, LOGAN,
LORAIN, LUCAS, MADISON,
MAHONING, MARION, MEDINA, MEIGS,
MERCER, MIAMI, MONROE,
MONTGOMERY, MORGAN, MORROW,
MUSKINGUM, NOBLE, OTTAWA,
PAULDING, PERRY, PICKAWAY, PIKE,
PORTAGE, PREBLE, PUTNAM,
RICHLAND, ROSS, SANDUSKY, SCIOTO,
SENECA, SHELBY, STARK, SUMMIT,
TRUMBULL, TUSCARAWAS, UNION,
VAN WERT, VINTON, WARREN,
WASHINGTON, WAYNE, WILLIAMS,
WOOD, WYANDOT

Special Jurisdictional Note :**Details :**

** Asphalt - Oil spray bar man when operating from cab shall receive \$0.20 cents per hour above their Basic Hourly Rate.

Prevailing Wage Rate Skilled Crafts

Name of Union: Sprinkler Fitter Local 669

Change # : LCN02-2019fbLoc669

Craft : Sprinkler Fitter Effective Date : 01/22/2020 Last Posted : 01/22/2020

	BHR		Fringe Benefit Payments						Irrevocable Fund		Total PWR	Overtime Rate
			H&W	Pension	App Tr.	Vac.	Annuity	Other	LECET (*)	MISC (*)		
Classification												
Sprinkler Fitter	\$39.07		\$10.23	\$6.80	\$0.52	\$0.00	\$5.12	\$0.10	\$0.00	\$0.00	\$61.84	\$81.37
Apprentice Indentured after April 1, 2013	Percent											
CLASS 1	45.00	\$17.58	\$7.75	\$0.00	\$0.52	\$0.00	\$0.00	\$0.10	\$0.00	\$0.00	\$25.95	\$34.74
CLASS 2	50.00	\$19.53	\$7.75	\$0.00	\$0.52	\$0.00	\$0.00	\$0.10	\$0.00	\$0.00	\$27.91	\$37.67
CLASS 3	55.00	\$21.49	\$10.23	\$6.80	\$0.52	\$0.00	\$0.65	\$0.10	\$0.00	\$0.00	\$39.79	\$50.53
CLASS 4	60.00	\$23.44	\$10.23	\$6.80	\$0.52	\$0.00	\$0.65	\$0.10	\$0.00	\$0.00	\$41.74	\$53.46
CLASS 5	65.00	\$25.40	\$10.23	\$6.80	\$0.52	\$0.00	\$0.90	\$0.10	\$0.00	\$0.00	\$43.95	\$56.64
CLASS 6	70.00	\$27.35	\$10.23	\$6.80	\$0.52	\$0.00	\$0.90	\$0.10	\$0.00	\$0.00	\$45.90	\$59.57
CLASS 7	75.00	\$29.30	\$10.23	\$6.80	\$0.52	\$0.00	\$0.90	\$0.10	\$0.00	\$0.00	\$47.85	\$62.50
CLASS 8	80.00	\$31.26	\$10.23	\$6.80	\$0.52	\$0.00	\$0.90	\$0.10	\$0.00	\$0.00	\$49.81	\$65.43
CLASS 9	85.00	\$33.21	\$10.23	\$6.80	\$0.52	\$0.00	\$0.90	\$0.10	\$0.00	\$0.00	\$51.76	\$68.36
CLASS 10	90.00	\$35.16	\$10.23	\$6.80	\$0.52	\$0.00	\$0.90	\$0.10	\$0.00	\$0.00	\$53.71	\$71.29

Special Calculation Note : \$0.10 for Other is National Fire Sprinkler Association

Ratio :

1 Journeyman to 1 Apprentice

Jurisdiction (* denotes special jurisdictional note) :

ADAMS, ALLEN, ASHLAND, ASHTABULA, ATHENS, AUGLAIZE, BELMONT, BROWN, BUTLER, CARROLL, CHAMPAIGN, CLARK, CLERMONT, CLINTON, COLUMBIANA, COSHOCTON, CRAWFORD, DARKE, DEFIANCE, DELAWARE, ERIE, FAIRFIELD, FAYETTE, FRANKLIN, FULTON, GALLIA, GREENE, GUERNSEY, HAMILTON, HANCOCK, HARDIN, HARRISON, HENRY, HIGHLAND, HOCKING, HOLMES, HURON, JACKSON, JEFFERSON, KNOX, LAWRENCE, LICKING, LOGAN, LUCAS, MADISON, MAHONING, MARION, MEDINA, MEIGS, MERCER, MIAMI, MONROE, MONTGOMERY, MORGAN, MORROW, MUSKINGUM, NOBLE, OTTAWA, PAULDING, PERRY, PICKAWAY, PIKE, PORTAGE, PREBLE, PUTNAM, RICHLAND, ROSS, SANDUSKY, SCIOTO, SENECA, SHELBY, STARK, SUMMIT, TRUMBULL, TUSCARAWAS, UNION, VAN WERT, VINTON, WARREN, WASHINGTON, WAYNE, WILLIAMS, WOOD, WYANDOT

Special Jurisdictional Note :

Details :

Sprinkler Fitter work shall consist of the installation, dismantling, maintenance, repairs, adjustments, and corrections of all fire protection and fire control systems including the unloading, handling by hand, power equipment and installation of all piping or tubing, appurtenances and equipment pertaining thereto, including both overhead and underground water mains, fire hydrants and hydrant mains, standpipes and hose connections to sprinkler systems used in connection with sprinkler and alarm systems. Also all tanks and pumps connected thereto, also included shall be CO-2 and Cardox Systems, Dry Chemical Systems, Foam Systems and all other fire protection systems.

3 Journeymen to 1 Apprentice
per company/project

note) :

ADAMS, ALLEN, ASHLAND, ASHTABULA,
ATHENS, AUGLAIZE, BELMONT, BROWN,
BUTLER, CARROLL, CHAMPAIGN, CLARK,
CLERMONT, CLINTON, COLUMBIANA,
COSHOCOTON, CRAWFORD, DARKE, DEFIANCE,
DELAWARE, ERIE, FAIRFIELD, FAYETTE,
FRANKLIN, FULTON, GALLIA, GREENE,
GUERNSEY, HAMILTON, HANCOCK, HARDIN,
HARRISON, HENRY, HIGHLAND, HOCKING,
HOLMES, HURON, JACKSON, JEFFERSON,
KNOX, LAWRENCE, LICKING, LOGAN, LORAIN,
LUCAS, MADISON, MAHONING, MARION,
MEDINA, MEIGS, MERCER, MIAMI, MONROE,
MONTGOMERY, MORGAN, MORROW,
MUSKINGUM, NOBLE, OTTAWA, PAULDING,
PERRY, PICKAWAY, PIKE, PORTAGE, PREBLE,
PUTNAM, RICHLAND, ROSS, SANDUSKY,
SCIOTO, SENECA, SHELBY, STARK, SUMMIT,
TRUMBULL, TUSCARAWAS, UNION, VAN WERT,
VINTON, WARREN, WASHINGTON, WAYNE,
WILLIAMS, WOOD, WYANDOT

Special Jurisdictional Note :

Details :

** Asphalt - Oil spray bar man when operating from cab shall receive \$0.20 cents per hour above their Basic Hourly Rate.